

# TOP-DL20

*Control unit with dimmer function for wired or radio  
control of up to 20 devices with DALI input  
110-240 Vac power supply  
Radio receiver 433.92MHz.*

**LEF**  
Lighting

linea

**NEXTA**  
RADIO



---

## INDEX

### 1 - PRODUCT FEATURES

- 1.1 - TECHNICAL DATA
- 1.2 - DESCRIPTION

### 2 - ELECTRICAL CONNECTION

- 2.1 - CONNECTION DIAGRAM
- 2.2 - DESCRIPTION OF CONNECTIONS

### 3 - USE OF THE CONTROL UNIT

- 3.1 - USE VIA RADIO
- 3.2 - USE VIA WIRE

### 4 - CONTROL UNIT SETTINGS

- 4.0 - FACTORY SETTINGS, RESET CONTROL UNIT
- 4.1 - RADIO PROGRAMMING OF MULTIFUNCTIONAL AND GENERIC TRANSMITTERS
- 4.2 - CANCELLAZIONE RADIO
- 4.3 - "SAVE" FUNCTION (BRIGHTNESS LEVEL AT SWITCH-ON)
- 4.4 - LOAD STATE WHEN THE CONTROL UNIT IS SWITCHED ON
- 4.5 - TIMED ON
- 4.6 - DIAGNOSTIC MENU

# 1 - PRODUCT FEATURES

## 1.1 TECHNICAL DATA

|                                 |                |
|---------------------------------|----------------|
| Power supply                    | 110-240 Vac    |
| Output                          | DALI BUS       |
| N° of programmable transmitters | 40             |
| Radio frequency                 | 433.920mhz ISM |
| Protection rating               | IP20           |
| Operating temperature           | -20 +55 °C     |
| Dimensions                      | 174x46x35 mm   |

Picture 1.1a

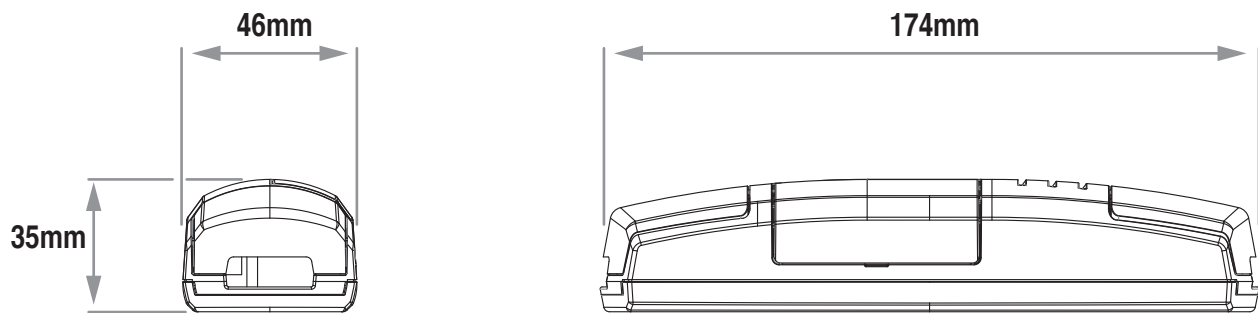

Picture 1.1b

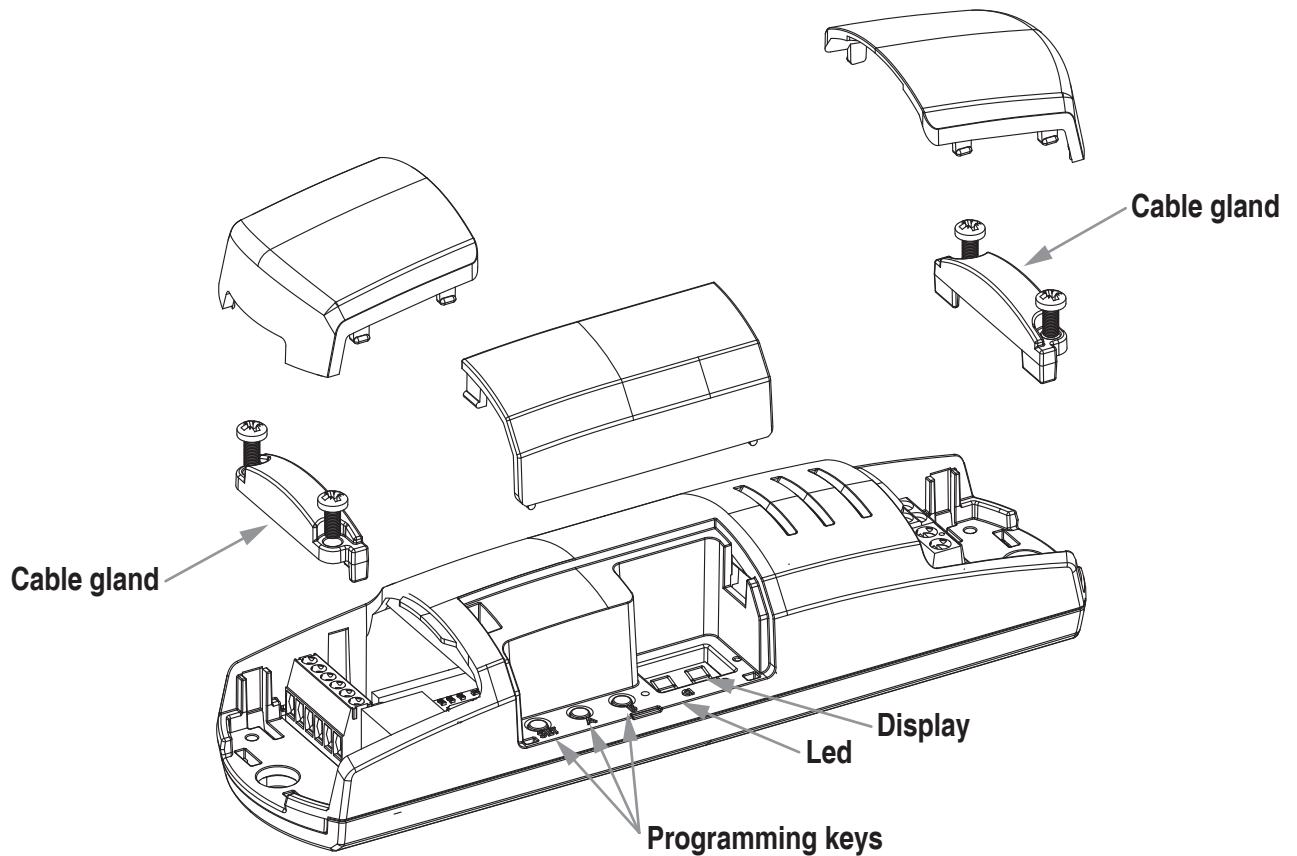

## 1.2 DESCRIPTION

Control unit with dimmer function for devices with DALI input such as electrical ballasts and transformers for fluorescent lamps.

The ISM (industrial, scientific and medical) radio frequency band guarantees a long range, even through walls and ceilings.

Programming via the display is quick and intuitive while its compact size mean it can be easily installed in false ceilings (picture 1.2b) and interconnection boxes (picture 1.2c).

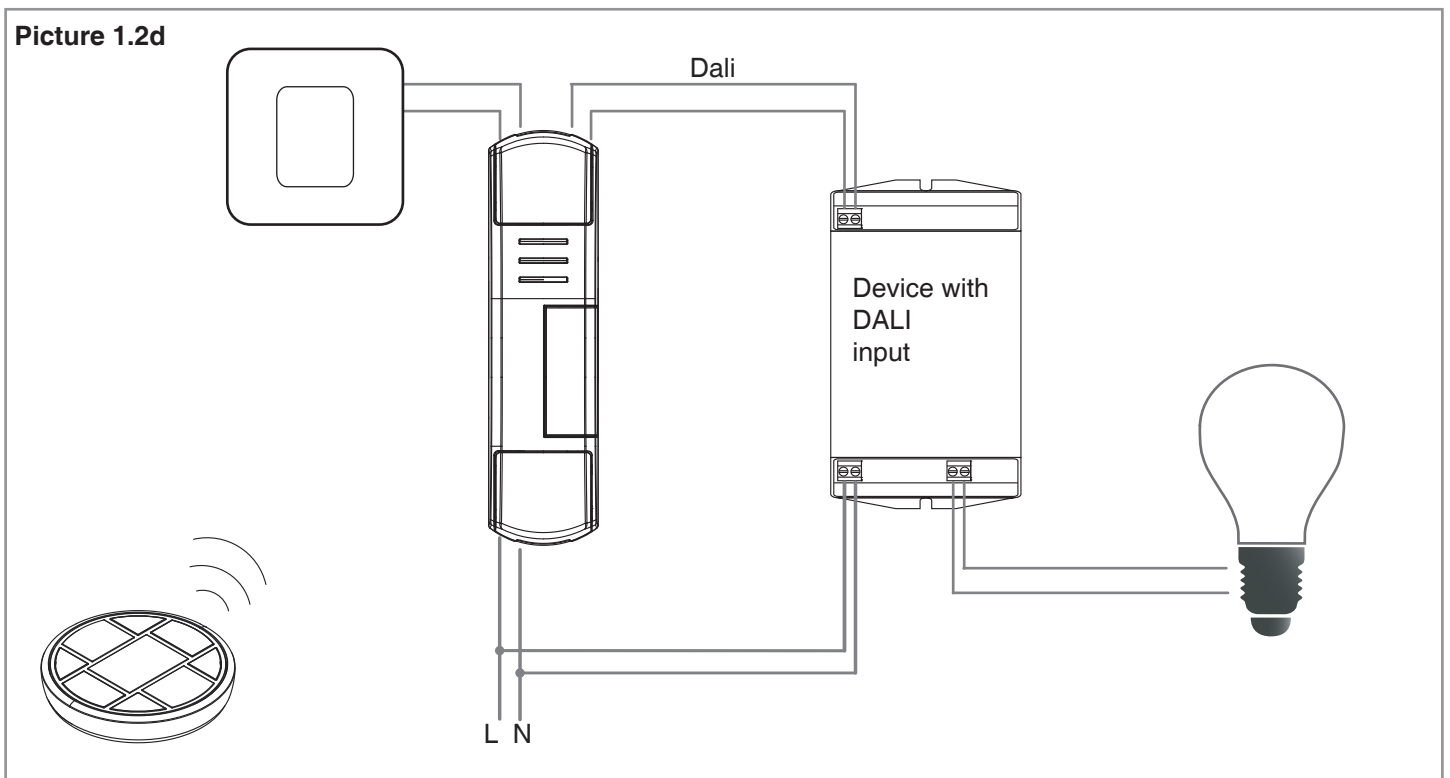
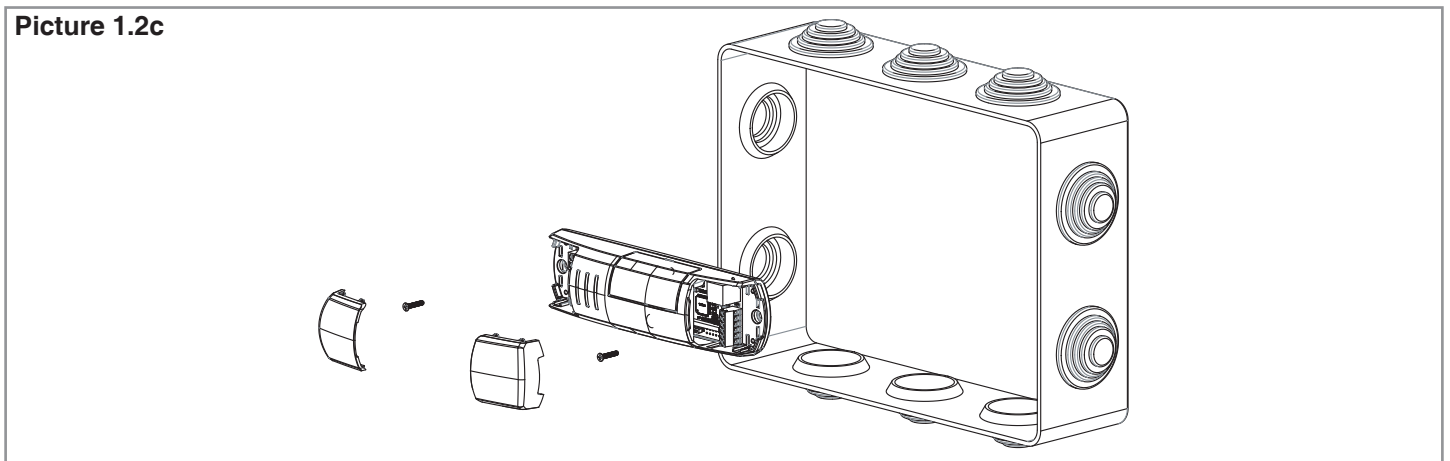
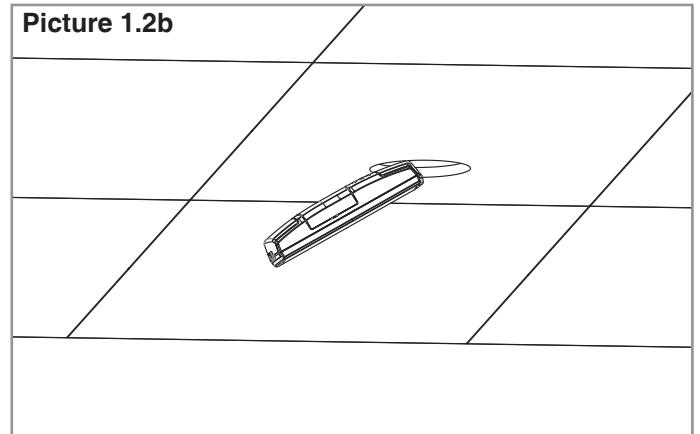
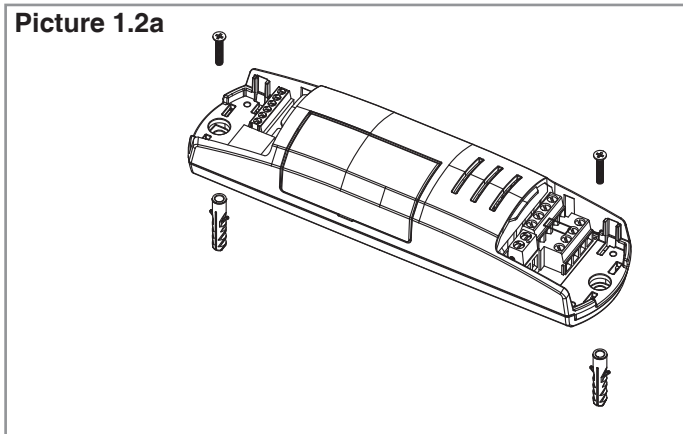

# 2 ELECTRICAL CONNECTION

## 2.1 CONNECTION DIAGRAM

Picture 2.1

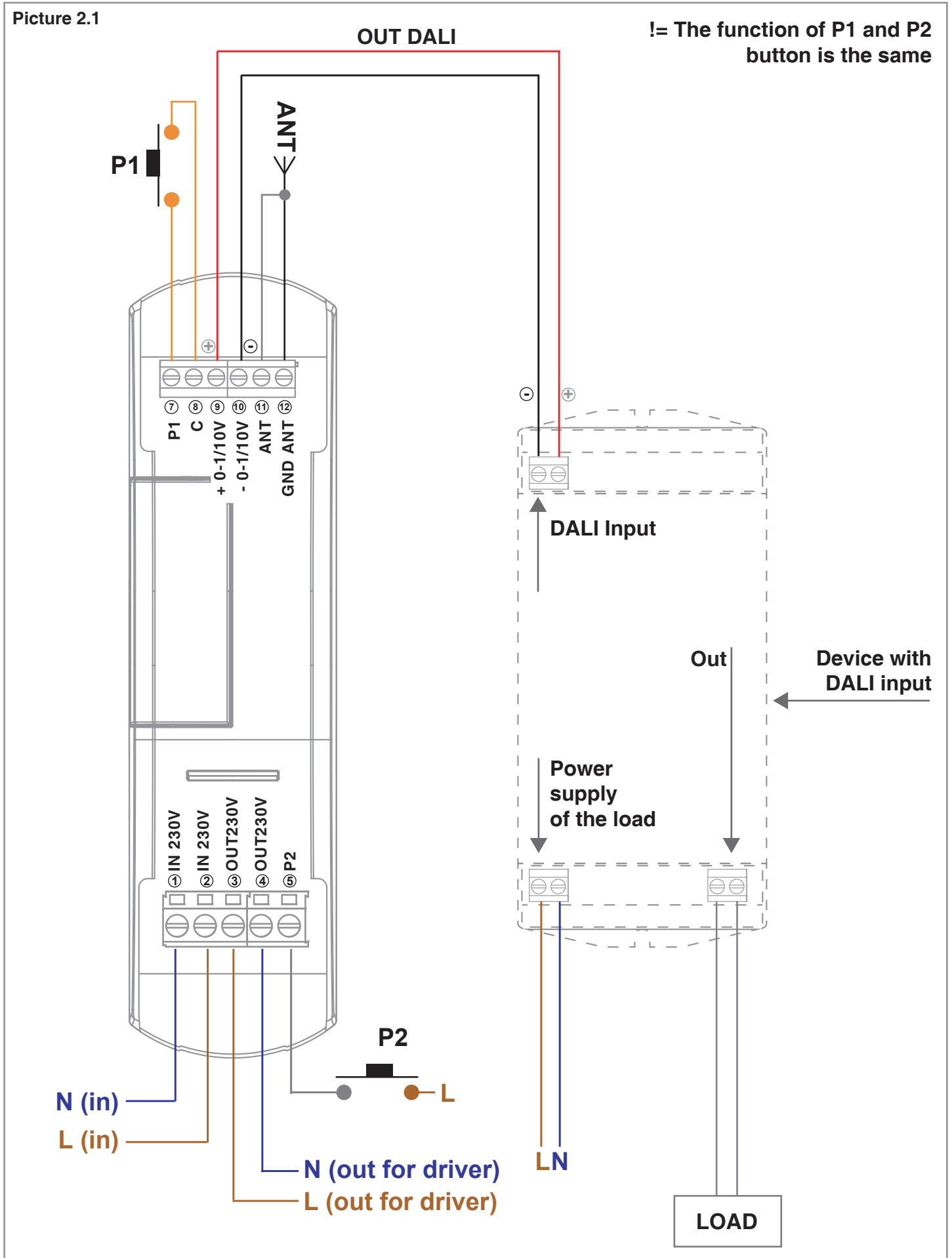

**NOTE:** multiple buttons or loads can be connected by using parallel cabling.

## 2.2 DESCRIPTION OF CONNECTIONS

Not all loads and buttons need to be connected for the control unit to operate correctly.

- Use wires with a suitable cross-section for the load connected.
- Multiple buttons can be connected by using parallel cabling.
- Multiple buttons or loads can be connected by using parallel cabling.
- The function of P1 and P2 buttons is the same. For a better connection the common of P1 is the terminal 8, the common of P2 is the phase of the system.

| TERMINAL | DESCRIPTION          |
|----------|----------------------|
| 1        | Power supply 230V    |
| 2        | Power supply 230V    |
| 3        | Out 230V             |
| 4        | Out 230V             |
| 5        | Button P2 input      |
| 6        | Button P1 input      |
| 7        | Common for button P1 |
| 8        | + DALI               |
| 9        | - DALI               |
| 10       | Aerial sleeve        |
| 11       | Aerial signal        |

---

## 3 USE OF THE CONTROL UNIT

### 3.1 USE VIA RADIO

To control the loads via radio you must have compatible transmitters and therefore must carry out the association procedure, see paragraph 4.1.

The transmitter's control modes depend on the transmitter model used.

If the transmitter is of a generic type, its operation depends on the way it is programmed (see paragraph 4.1, table 4.1c).

If the transmitter is multifunctional, refer to the transmitter manual, to the paragraph entitled "commands sent by the transmitter", bearing in mind that it is a "dimmer" device.

---

### 3.2 USE VIA WIRE

The device is set up to accept commands via wire by button in terminals 1 and 7.

Should you want to control the load only via radio, it is not necessary to connect these devices for the control unit to work properly.

The behaviour of the different keys is shown in the following table:

|   | LOAD OFF                    | LOAD ON   |
|---|-----------------------------|---|
| <b>INPUT P1=</b><br><b>INPUT P2:</b><br>short press | Load on                     | Load off  |
| <b>INPUT P1=</b><br><b>INPUT P2:</b><br>long press  | Dimmer intensity up of load | Dimmer intensity up / Dimmer intensity down of load |

## 4 CONTROL UNIT SETTINGS

In the programming zone (see picture 4) you can access the programming menu using the keys and the display. Short presses on the "SET" key let you scroll through the different programmable functions visible on the display ("P1", "P2"...). Prolonged pressure on the "SET" key (approx. 3 seconds) allows access to the menu for the function selected.

The different types of programming available are:

- "P1": programming of radio
- "P2": deletion of radio
- "P3": activation/deactivation of memory of last value at switch-on
- "FS": factory setting, reset control unit

After 60 seconds' inactivity (no keys pressed), the control unit goes into stand-by with the displays switched off.

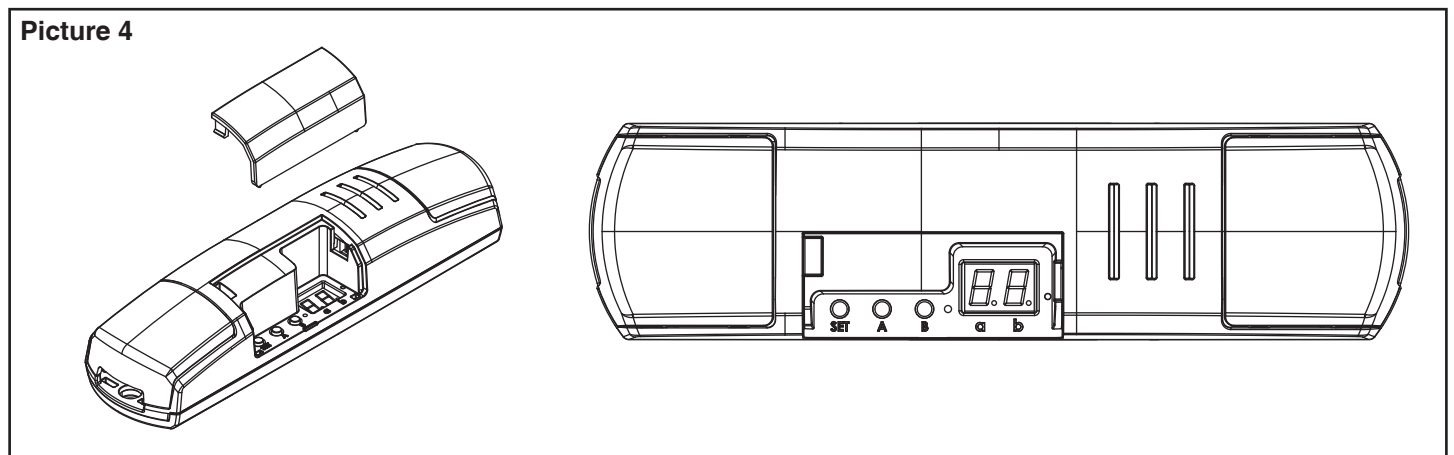

## 4.0 MENU "P0": SELEZIONE DELLA TIPOLOGIA DI CARICO

Default: mode 1

This is not necessary for the system to function properly. It may be useful for improving the operation of some transmitters (examples: Touch-1DIM, HB80-1DIM, HB80-4DIM, HUB100).

This procedure configures the DALI scale used to get the change of intensity. The correct setting depends on the characteristics of the attached load, because not all DALI drivers respond in the same way.

### PROCEDURE:

#### STEP 1

Short presses on the "SET" key let you scroll through the menu until "P0" programming appears on the display.

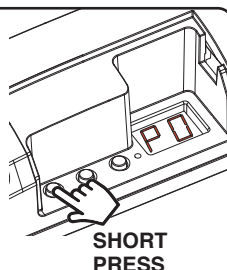

#### STEP 2

A prolonged press on the "SET" key (approx. 3 seconds) takes you into programming. The LED on the receiver lights up

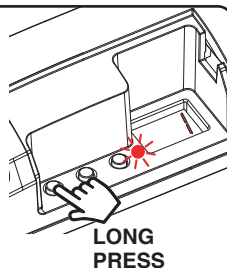

#### STEP 3

Make short presses on key "B" to choose the setting you want to set based on table alongside.

| DISPLAY | TYPE OF DIMMER               |
|---------|------------------------------|
| 1       | Dali intensity scale "mode1" |
| 2       | Dali intensity scale "mode2" |
| 3       | Dali intensity scale "mode3" |

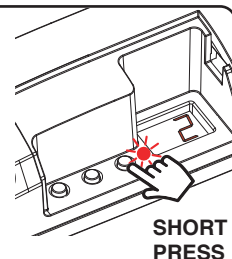

#### STEP 4

To confirm give a prolonged press on the "SET" key (approx. 3 seconds).

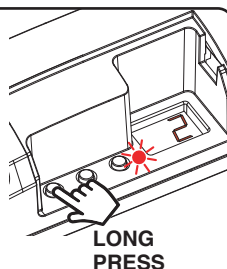

#### STEP 5

The control unit goes back to the menu displaying the different types of programming.

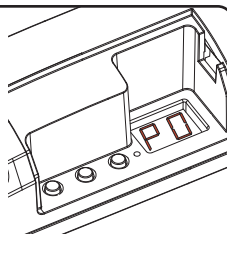

## 4.1 MENU "P1": RADIO PROGRAMMING

This procedure lets you programme compatible multifunctional or generic transmitters.

### WHICH REMOTE CONTROL DO YOU WANT TO ASSOCIATE WITH THE CONTROL UNIT?

#### MULTIFUNCTIONAL TRANSMITTERS

**CODES:**

HB70-SLCT, HB70-SPCT,  
HB80-1C, HB80-1DIM, HB80-2L, HB80-30D, HB80-30RGBW, HB80-4C, HB80-4DIM, HB80-4L,  
HB90-6LT,  
ROUND-1SP,  
SENSA-M, SENSA-P, SENSA-R35M, SENSA-R35P, SENSA-R35T, SENSA-T,  
TOUCH-1, TOUCH-1CCT, TOUCH-1DIM, TOUCH-1SP, TOUCH-1L, TOUCH-1RGBW, TOUCH-3C, TOUCH-4DIM, TOUCH-CFU

With multifunctional transmitters the transmitter control modes depend on the model used. Refer to the transmitter manual, to the paragraph entitled "commands sent by the transmitter", bearing in mind that it is an "dimmer" device.

#### GENERIC TRANSMITTERS (WIRELESS BUS)

**CODES:**

HB80-6G,  
MCU-TX4,  
TOUCH-1G, TOUCH-2G, TOUCH-4G, TOUCH-LOCK4, TOUCH-TX2,  
ROUND-1G

With generic transmitters, the transmitter's control modes depend on the function associated with the key during the association procedure.

The available function for the key are:

**TABLE 4.1 - KEY FUNCTIONS OF THE GENERIC TRANSMITTER**

| NUMBER TO BE SET IN "STEP 3b" OF THE PROCEDURE | KEY FUNCTION  |
|--|---|
| 2  | ON/OFF  |
| 3  | ON  |
| 4  | OFF   |
| 5  | Dimmer UP   |
| 6  | Dimmer DOWN   |
| 7  | <b>Short press:</b> ON/OFF<br><b>Prolonged press:</b> Dimmer intensity UP/ DOWN |
| 8  | <b>Short press:</b> ON<br><b>Prolonged press:</b> Dimmer intensity UP           |
| 9  | <b>Short press:</b> OFF<br><b>Prolonged press:</b> Dimmer intensity DOWN        |
| 0  | Not used  |



# PROCEDURE

## STEP 1

Short presses on the "SET" key let you scroll through the menu until "P1" programming appears on the display.

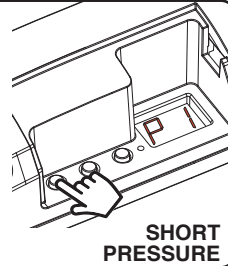

## STEP 2

A prolonged press on the "SET" key (approx. 3 seconds) takes you into programming.

The LED on the receiver comes on

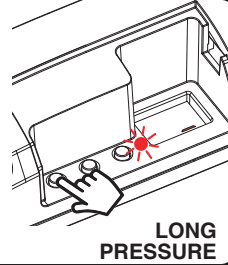

## WHICH TRANSMITTER DO YOU WANT TO PROGRAMME?

**MULTIFUNCTION TRANSMITTER**  
(see models and codes on previous page)

**GENERIC TRANSMITTER**  
(see models and codes on previous page)

## STEP 3a

Short presses on key "B" let you set value "1" on the display

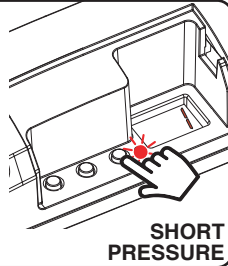

## STEP 3b

Short presses on key "B" let you choose the function you want to programme shown on the displays. See table 4.1 on the previous page.

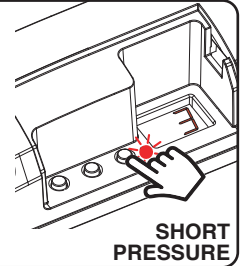

## STEP 4

Give a long press on key "B" (approx. 3 seconds).

The LED on the display comes on

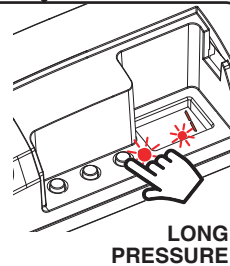

## STEP 5

Make a transmission with the transmitter to be saved (see transmitter manual, the paragraph entitled "transmitter programming").

The LED on the receiver flashes 3 times to signal that it has been received.

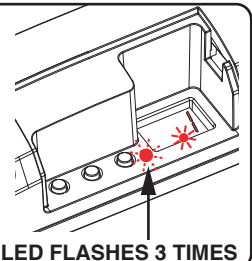

## STEP 6

The control unit listens for 50 seconds in case you want to add other transmitters. To immediately exit the procedure give a short pressure on key "b".

The LED on the display turns off

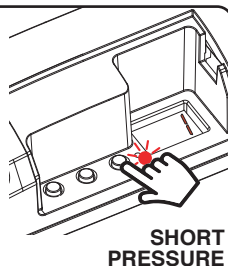

## STEP 7

The control unit goes back to the menu displaying the radio programming. If you want to save other transmitters, go back to point 3 of this procedure.

If you want to go back to the menu displaying the different types of programming, give a prolonged press to the "SET" key (approx. 3 seconds).

## 4.2 MENU "P2": DELETION OF RADIO

These procedures let you delete transmitters that have already been programmed from the receiver's memory.

### DELETION OF SINGLE TRANSMITTER CHANNEL:

#### STEP 1

Short presses on the "SET" key let you scroll through the menu until "P2" programming appears on the display.

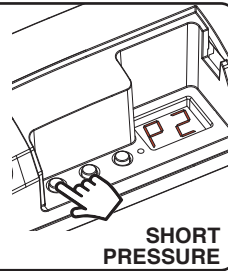

#### STEP 2

A prolonged press on the "SET" key (approx. 3 seconds) takes you into programming.

The LED on the receiver lights up

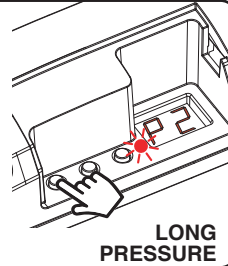

What is shown on display "a" and "b" has no influence on this procedure.

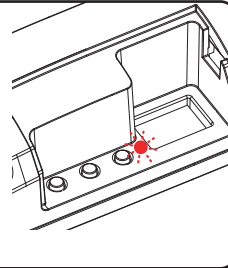

#### STEP 3

Give a long press on key "B" (approx. 3 seconds)

The LED on the receiver starts to flash

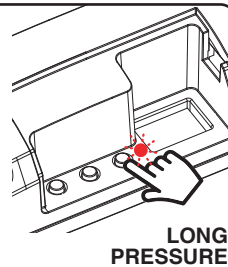

#### STEP 4

Within 5 seconds make a transmission with the remote control that you want to delete.

The LED on the receiver will flash rapidly and stay on



MAKE A TRANSMISSION WITH THE TRANSMITTER

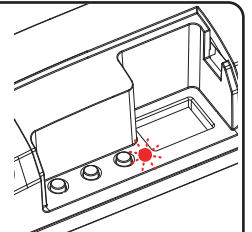

#### STEP 5

The control unit goes back to the menu displaying the radio deletion. If you want to delete other transmitters, go back to point 3 of this procedure.

If you want to go back to the menu displaying the different types of programming, give a prolonged press to the "SET" key (approx. 3 seconds).

## DELETION OF ALL THE SAVED TRANSMITTERS:

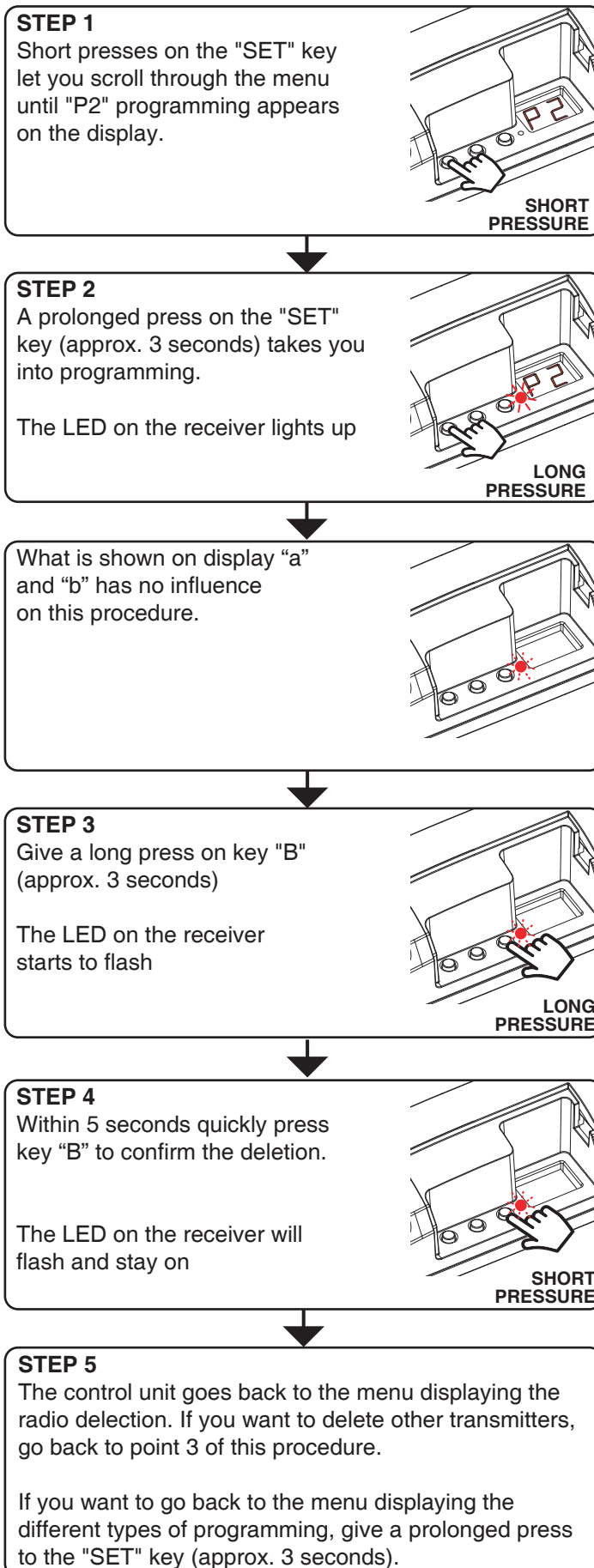

## 4.3 MENU "P3": "SAVE" FUNCTION (BRIGHTNESS LEVEL AT SWITCH-ON)

Default: all the loads come on at maximum brightness

With this procedure you can set the intensity value at which the loads come on.  
The setting will be effective for all the outputs.

### PROCEDURE:

**STEP 1**  
Short presses on the "SET" key let you scroll through the menu until "P3" programming appears on the display.

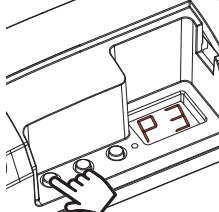

**SHORT PRESSURE**

**STEP 2**  
A prolonged press on the "SET" key (approx. 3 seconds) takes you into programming.  
The LED on the receiver lights up

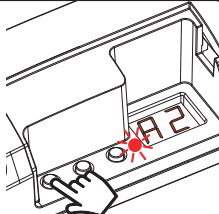

**LONG PRESSURE**

**STEP 3**  
Display "a" always shows the letter "A" (all).  
Make short presses on key "B" to choose the setting you want to set based on table alongside.

| DISPLAY | SAVE FUNCTION:<br>INTENSITY AT SWITCH-ON COMMAND  |
|---------|---|
| 1       | "SAVE" function on. The load will switch on at the last brightness value set before it was switched off |
| 2       | Switch-on of load at maximum intensity with white light   |

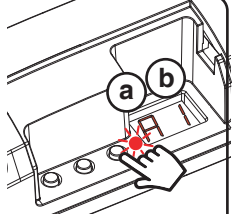

**SHORT PRESSURE**

**STEP 4**  
To confirm give a prolonged press on the "SET" key (approx. 3 seconds).

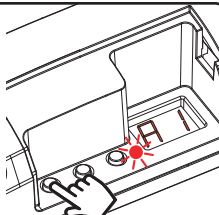

**LONG PRESSURE**

**STEP 5**  
The control unit goes back to the menu displaying the different types of programming.

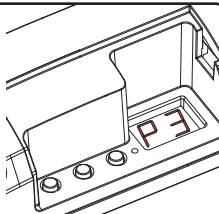

**WARNING:** the save function is activated/deactivated across all loads.

## 4.4 MENU "P4": LOAD STATE WHEN THE CONTROL UNIT IS SWITCHED ON

Default: Light Off

This process is used to set the state of Leds when the control unit is switched on (for example when the power supply is provided by a general switch or timer).

### PROCEDURE:

**STEP 1**  
Short presses on the "SET" key let you scroll through the menu until "P4" programming appears on the display.

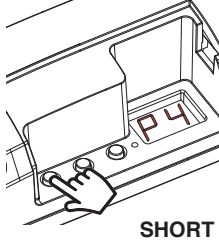

SHORT PRESSURE

**STEP 2**  
A prolonged press on the "SET" key (approx. 3 seconds) takes you into programming.  
  
The LED on the receiver lights up

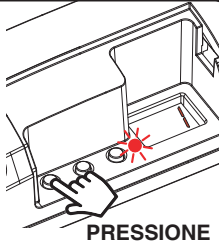

PRESSIONE LUNGA

**STEP 3**  
Short presses on key "B" let you choose the function you want to programme shown on the displays based on what is shown in the table alongside

| DISPLAY | BRIGHTNESS AT SWITCH-ON  |
|---------|--|
| 1       | Default (light off)  |
| 2       | The light switches on in the same status as the load is currently in:<br>Set the desired status of light |



PRESSIONE BREVE

**STEP 4**  
To confirm give a prolonged press on the "SET" key (approx. 3 seconds).

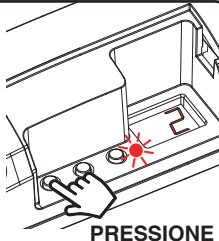

PRESSIONE LUNGA

**STEP 5**  
The control unit goes back to the menu displaying the different types of programming.

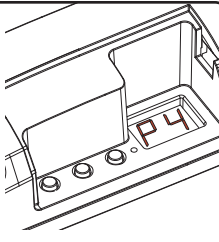

## 4.5 MENU "P5": TIMED ON

Default: No timing

This process is used to set the time for which the Leds stays on before an automatic switch off.

### PROCEDURE:

#### STEP 1

Short presses on the "SET" key let you scroll through the menu until "P5" programming appears on the display.

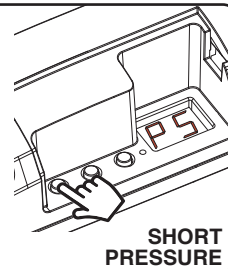

#### STEP 2

A prolonged press on the "SET" key (approx. 3 seconds) takes you into programming. The LED on the receiver lights up



#### STEP 3

Short presses on key "B" let you choose the timing that you want to programme shown on the displays based on what is shown in table alongside

| DISPLAY | TIMED ON   |
|---------|------------|
| 1       | No Timing  |
| 2       | 1 minute   |
| 3       | 5 minutes  |
| 4       | 15 minutes |
| 5       | 40 minutes |
| 6       | 1 hour     |
| 7       | 2 hours    |
| 8       | 3 hours    |
| 9       | 8 hours    |

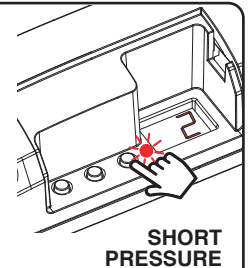

#### STEP 4

To confirm, give a prolonged press on the "SET" key (approx. 3 seconds).

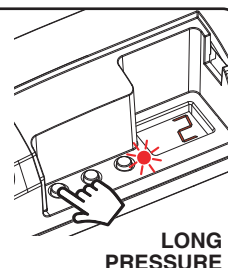

#### STEP 5

The control unit goes back to the menu displaying the different types of programming.

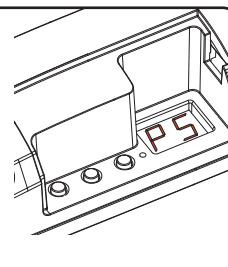

## 4.6 MENU "d0": DIAGNOSTIC MENU

Not used

## 4.7 MENU "FS": FACTORY SETTING, RESET DELLA CENTRALE

This procedure let you take the control unit back to factory settings.

### PROCEDURE:

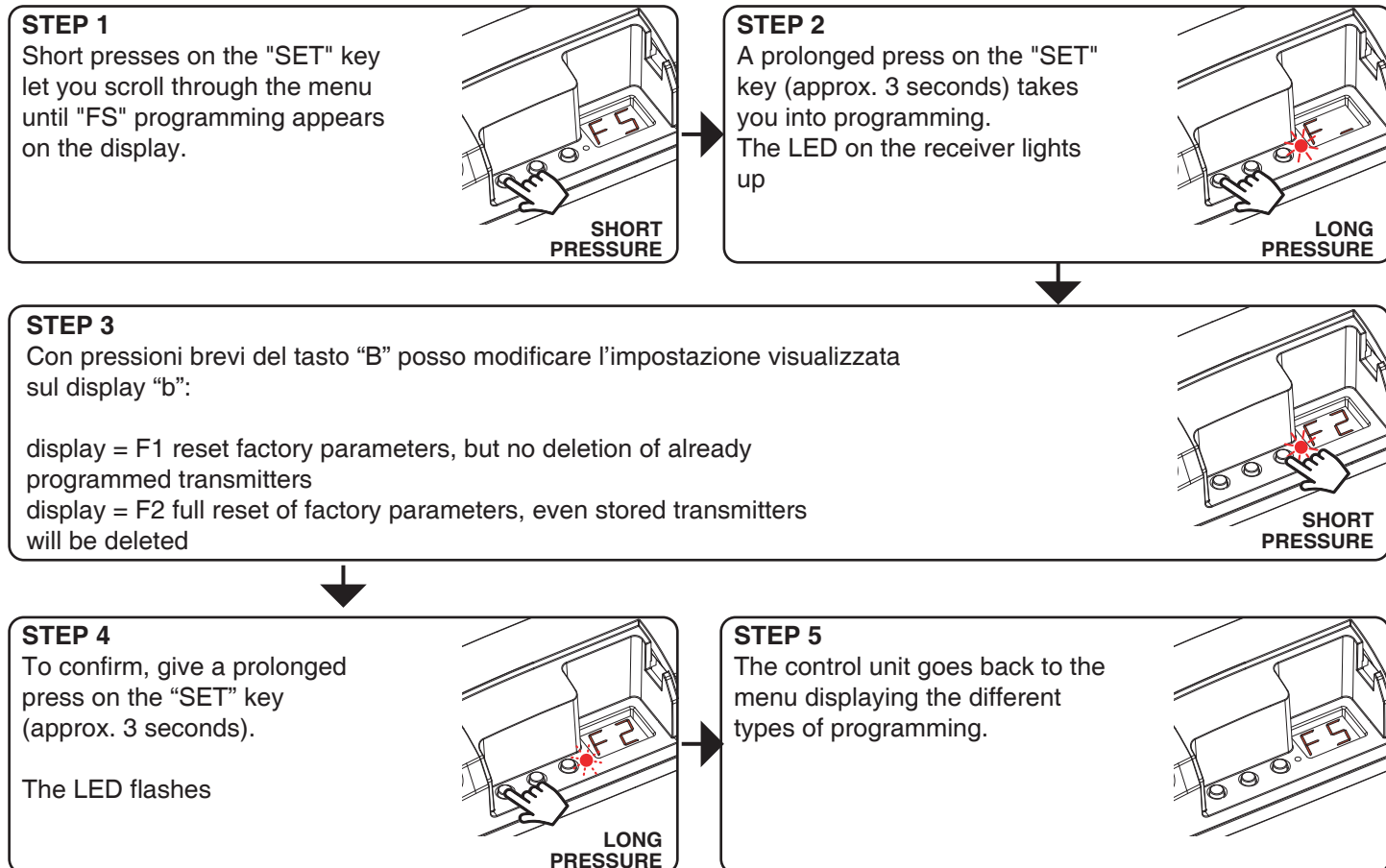











V2.0

**LEF**  
*Lighting*

**LEF LIGHTING S.R.L.**

Via Rodolfo Morandi 9/11

50019 Sesto Fiorentino

Tel. 055.4217727

Firenze - ITALY

[www.leflighting.it](http://www.leflighting.it)