

TOP-0110/ONE

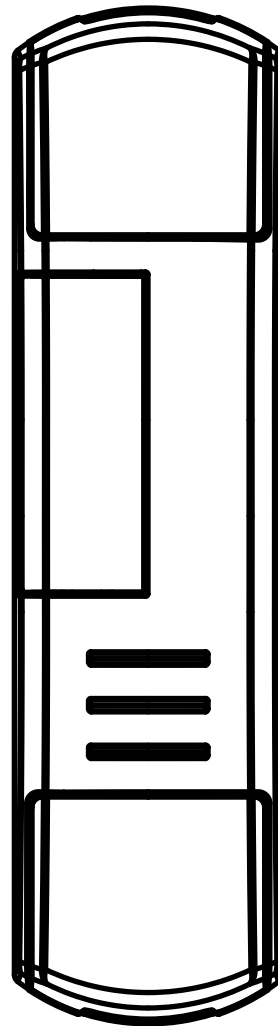

**Control unit with dimmer function for control devices with 0/1-10V input.
Power supply 230Vac, output: 0/1-10V signal and on/off manage up to 2000W load (230V) .
Integrated 433.92 MHz radio receiver.
WiFi connection for OneSmart App.**

INDEX

1 - PRODUCT FEATURES	
1.1 - TECHNICAL DATA	page 3
<hr/>	
2 - ELECTRICAL CONNECTION	
2.1 - SINGLE DEVICE CONNECTION DIAGRAM	page 4
2.2 - MULTIPLE DEVICE CONNECTION DIAGRAM	page 5
2.3 - SELECTION OF TYPE OF LOAD CONNECTED: "0-10V" OR "1-10V"	page 6
<hr/>	
3 - USE OF THE CONTROL UNIT	
3.1 - TYPICAL INSTALLATION	page 8
3.2 - USE VIA WIRE	page 9
3.3 - USE VIA RADIO	page 9
3.4 - USE VIA SMARTPHONE APP ONESMART	page 9
3.5 - USE WITH VOICE CONTROL	page 9
<hr/>	
4 - MANAGEMENT WITH REMOTE CONTROL	
4.1 - RADIO PROGRAMMING	page 10
4.2 - DELETION OF REMOTE CONTROL	page 11
<hr/>	
5 - CONTROL WITH APP ONE SMART™	
5.1 - APP CONNECTION	page 12
5.2 - USE OF THE APP ONE SMART™	page 13
<hr/>	
6 - CONTROL BY VOICE COMMANDS	
6.1 - CONNECTION TO "GOOGLE HOME"	page 14
6.2 - CONNECTION TO "AMAZON ALEXA"	page 13
<hr/>	
7 - ADVANCED PROGRAMS	
7.1 - FUNCTION CUSTOMIZATION OF THE "WIRELESS BUS" TRANSMITTER	page 18
7.2 - "SAVE" FUNCTION (BRIGHTNESS LEVEL AT SWITCH-ON)	page 19
7.3 - FADE SETTING: GRADUAL SWITCH-ON	page 20
7.4 - FADE SETTING: GRADUAL SWITCH-OFF	page 21
7.5 - SELECTION OF MINIMUM INTENSITY VALUE	page 22
7.6 - LOAD STATE WHEN THE CONTROL UNIT IS SWITCHED ON	page 23
7.7 - TIMED ON	page 24
7.8 - FACTORY SETTING, CONTROL UNIT RESET	page 25

1 - PRODUCT FEATURES

1.1 TECHNICAL DATA

Power supply (Input)	230 VAC
Type of load (Output)	Device with 0/1-10V input
Maximum load connectable on the On/Off Output	2000W, 230V
Available current on the 0/1-10V Output	
N° of programmable transmitters	30
RF receiver frequency	433.920MHz
WiFi frequency	2.4GHz
Protection rating	IP20
Working temperature	-20° +55°
Box dimensions	174x46x35 mm

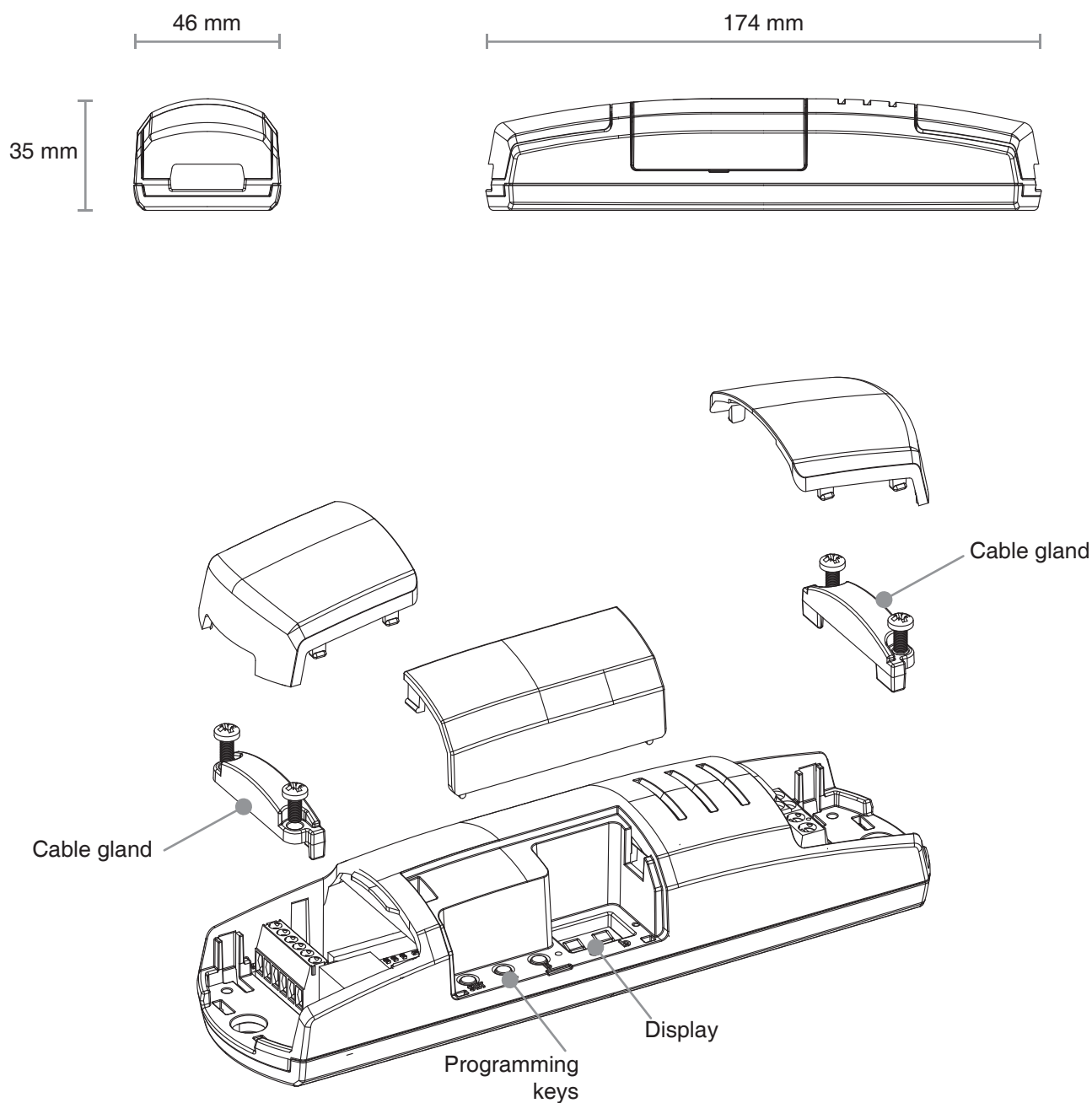

2 - ELECTRICAL CONNECTION DIAGRAMS

RECOMMENDATIONS

- Installation must be carried out only by professional technicians in accordance with the applicable electrical and safety regulations.
- All connections shall be operated without electrical voltage.
- Use proper cables.
- Don't cut the antenna
- Provide in the power line with an appropriate disconnection device
- Dispose of waste materials in full compliance with local law.
- Do not exceed the specified load limits and use correctly protected power supplies.

2.1 SINGLE DEVICE CONNECTION DIAGRAM

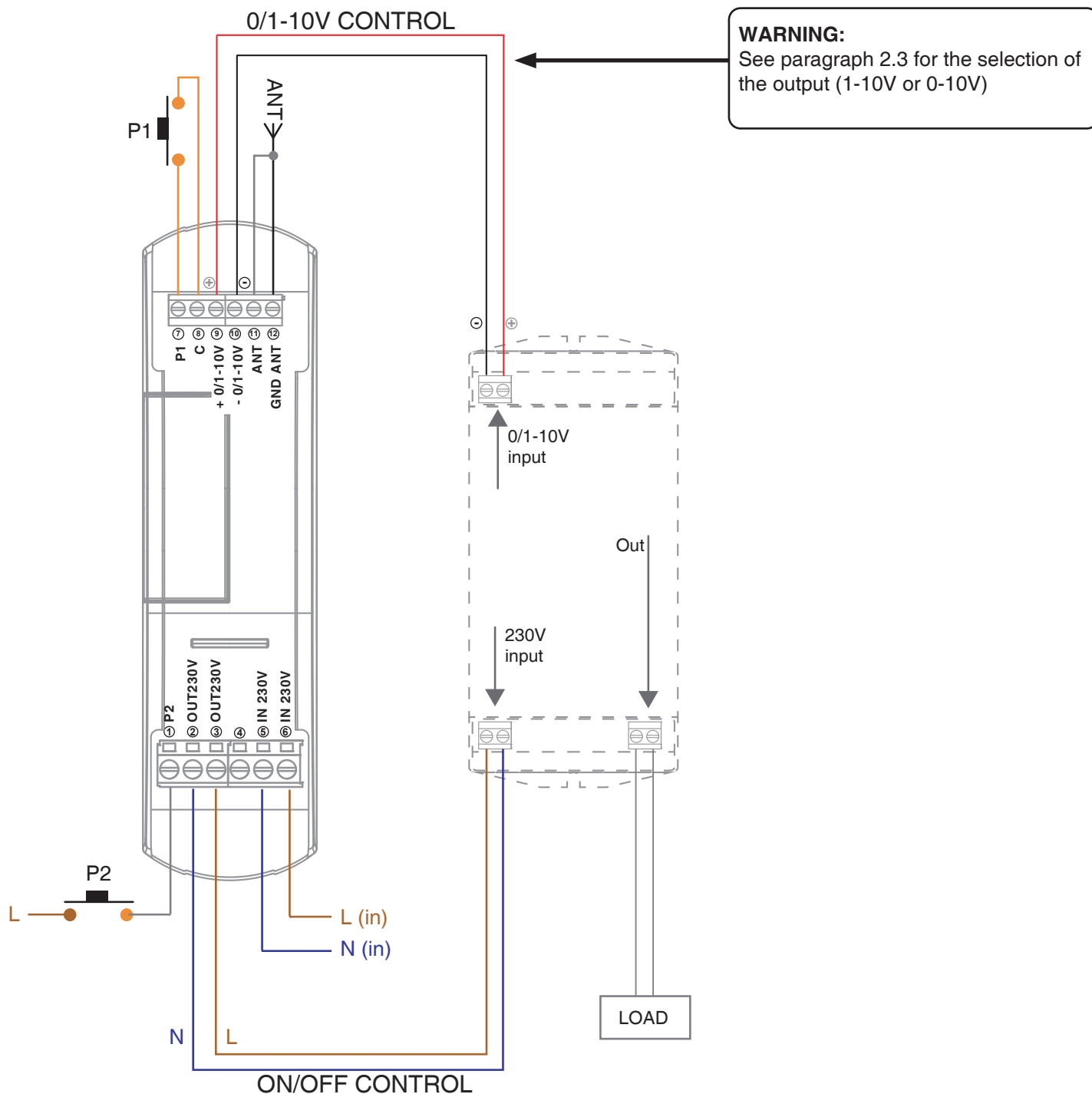

WARNING:

- P1 and P2 button have the same functions
- The function of the outputs is broadcast type (control every DALI address)

2.2 MULTIPLE DEVICE CONNECTION DIAGRAM

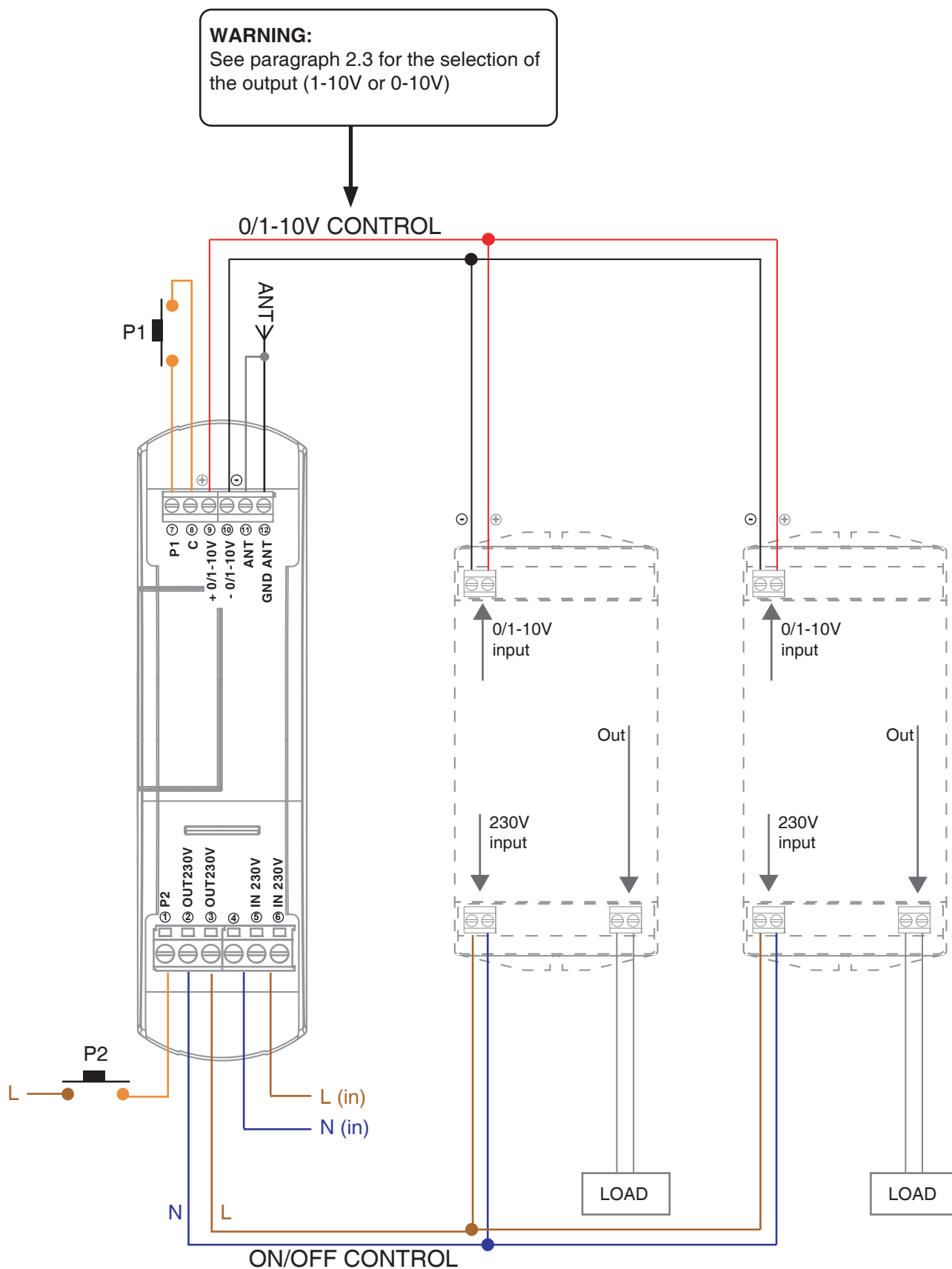

WARNING:

- P1 and P2 button have the same functions
- The function of the outputs is broadcast type (control every DALI address)

2.3 - SELECTION OF ATTACHED LOAD TYPE: "0-10V", "1-10V" or "On/Off"

Default: "1-10V"

0-10V = the output range will be from 0 to 10V. At the end of the "down" ramp the relay opens (230V)

1-10V = the output range will be from 1 to 10V. At the end of the "down" ramp the relay opens (230V)

On / Off = the opening and closing of the relay (230V) are immediately without waiting for the 1 / 0-10V ramp.

The correct setting depends on the characteristics of the connected load.

PROCEDURE

STEP 1

Short presses on the "SET" key let you scroll through the menu until "P0" programming appears on the display.

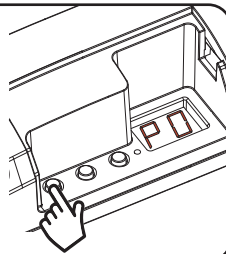

STEP 2

A prolonged press on the "SET" key (approx. 3 seconds) takes you into programming. The LED on the receiver lights up

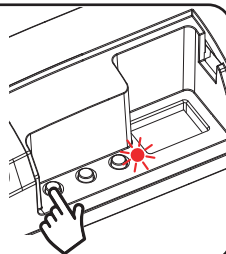

STEP 3

Short presses on key "B" let you choose the function you want to programme shown on the displays based on what is shown in the table alongside

DISPLAY	TYPE OF CONTROL
1	1-10V
2	0-10V
3	On/Off (no fade ON or OFF)

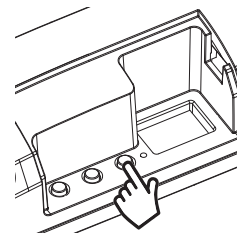

STEP 4

To confirm give a long press on the "SET" key (approx. 3 seconds). The control unit goes back to the menu displaying the different types of programming.

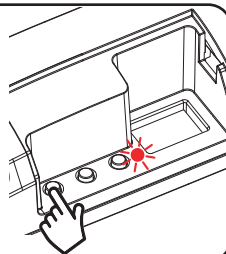

3 - USE OF THE CONTROL UNIT

3.1 TYPICAL INSTALLATION

The system can be controlled by a wired push button, radio commands, smartphone App OneSmart or voice commands. The installation can operate with only radio controls or application only. Instead, to use voice commands, at least the App configuration must be completed.



**RADIOTRANSMITTER
CONFIGURATION**

See paragraph 4

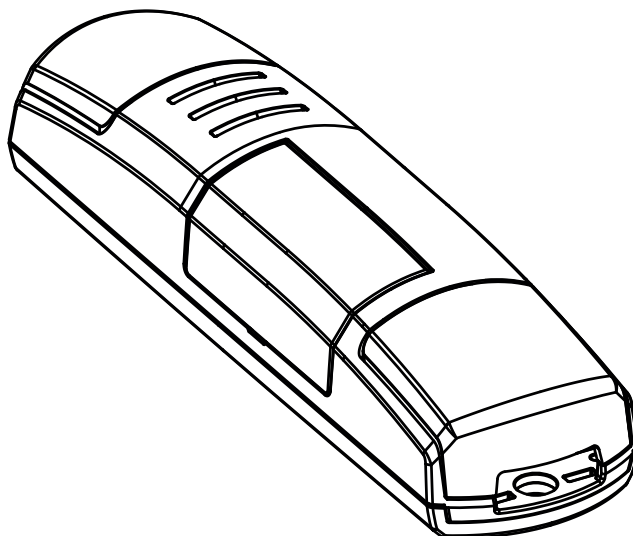

NEXTA CONTROL UNIT

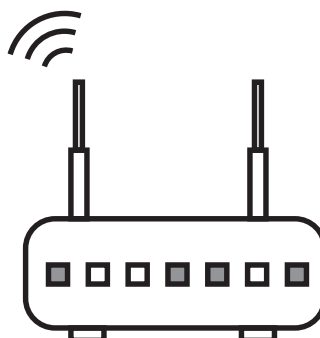

**ROUTER WITH INTERNET
CONNECTION**



**APP CONTROL
CONFIGURATION**

See paragraph 5



**VOICE CONTROL
CONFIGURATION**

See paragraph 6

3.2 USE VIA WIRE

Depending on the output type you set, the button will have several functions. See paragraph 2 for details.

	LIGHT ON	LIGHT OFF
SHORT PRESS OF BUTTON P1 OR P2	Turns off the light	Turns on the light
LONG PRESS OF BUTTON P1 OR P2	Dimmer Down / Up (only in 0/1-10V mode)	Dimmer Up (only in 0/1-10V mode)

3.3 USE VIA RADIO

To control the loads via radio you must have compatible transmitters and therefore must carry out the association procedure, see paragraph 4.

3.4 USE VIA SMARTPHONE APP ONESMART

The configuration procedures described in paragraph 5 above must be followed to control the lights by smartphone App.

3.5 USE WITH VOICE CONTROL

The configuration procedures described in paragraph 6 above must be followed to control the lights by voice commands.

4 - MANAGEMENT WITH REMOTE CONTROL

This procedure lets you programme/delete compatible multifunctional or generic (Wireless bus) transmitters

Multifunctional transmitters, codes:

HB70-SLCT, HB70-SPCT,
HB80-1C, HB80-1DIM, HB80-2L, HB80-30D, HB80-30RGBW, HB80-4C, HB80-4DIM, HB80-4L,
HB90-6LT,
ROUND-1SP,
SENSA-M, SENSA-P, SENSA-R35M, SENSA-R35P, SENSA-R35T, SENSA-T,
TOUCH-1, TOUCH-1CCT, TOUCH-1DIM, TOUCH-1SP, TOUCH-1L, TOUCH-1RGBW, TOUCH-3C, TOUCH-4DIM, TOUCH-CFU

With multifunctional transmitters the transmitter control modes depend on the model used.

Refer to the transmitter manual, to the paragraph entitled “commands sent by the transmitter”, bearing in mind that:

single-color mode= dimmer

tunable white mode= CCT

rgb / rgbw mode= RGB/W

Generic (wireless bus) transmitters, codes:

HB80-6G, MCU-TX4, TOUCH-1G, TOUCH-2G, TOUCH-4G, TOUCH-LOCK4, TOUCH-TX2, ROUND-1G

With generic transmitters, the function of the button is:

SHORT PRESS: On/Off

LONG PRESS, LIGHT ON: dimmer Up/Down

LONG PRESS, LIGHT OFF: dimmer Up

The functions of the generic transmitters can be customized using the procedure in paragraph 7.1.

4.1 - RADIO PROGRAMMING

This procedure lets you programme compatible multifunctional or generic transmitters.

STEP 1

From Stand by condition (display off), press the button “B”.

On the display appears “L”

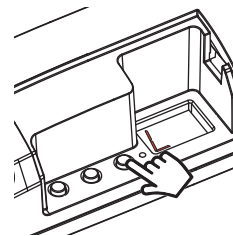

ACTION: Short press of button “B” **DISPLAY:** “L”

STEP 2

Within 60 seconds make a transmission with the transmitter to be saved.

See transmitter manual, the paragraph entitled “transmitter programming” for specify information.

The display makes 3 Flashes and turns off.

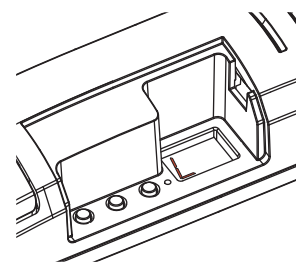
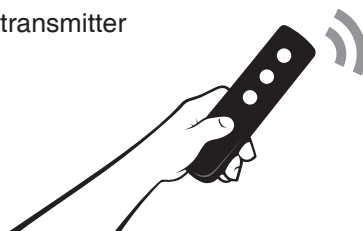

ACTION: Make a transmission with the transmitter **LED:** Flashes 3 times

4.2 - DELETION OF REMOTE CONTROL

These procedures let you delete from the memory transmitters that have already been programmed.

STEP 1

Short presses on the "SET" key let you scroll through the menu until "P2" programming appears on the display.

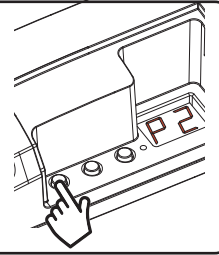

ACTION: Short press of button "SET" **DISPLAY:** "P2"

STEP 2

A prolonged press on the "SET" key (approx. 3 seconds) takes you into programming.

The LED on the receiver lights up

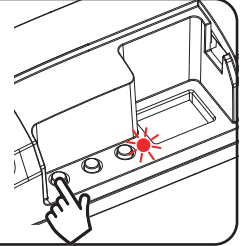

ACTION: Prolonged press of button "SET" **DISPLAY:** "P2"

DELETION OF SINGLE TRANSMITTER

STEP 2a

Give a long press on key "B" (approx. 3 seconds). The LED on the receiver starts to Flash

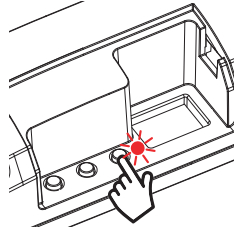

ACTION: Prolonged press of button "B"
LED: Flashes

DELETION OF ALL TRANSMITTER SAVED

STEP 2b

Give a long press on key "B" (approx. 3 seconds). The LED on the receiver starts to Flash

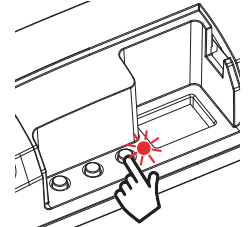

ACTION: Prolonged press of button "B"
LED: Flashes

STEP 2a

Within 5 seconds make a transmission with the remote control that you want to delete. The LED on the receiver will Flash rapidly and stay on



ACTION: Make a transmission with the transmitter
LED: Flashing quickly and turns off

STEP 3b

Within 5 seconds quickly press key "B" to confirm the deletion. The LED on the receiver will Flash and stay on

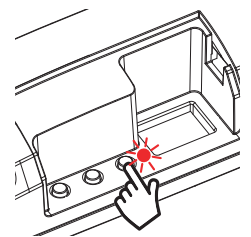

ACTION: Short press of button "SET"
LED: Flashing quickly and turns off

5 - CONTROL WITH APP ONE SMART

These procedures allow you to manage the light from your device (example: mobile phone) through the application and to control the system remotely.

5.1 - APP CONNECTION

This procedure connects the control unit Plano-One to the application. It shall be repeated for each control unit on the installation.

ATTENTION: an internet-based wi-fi network is required for te operation.

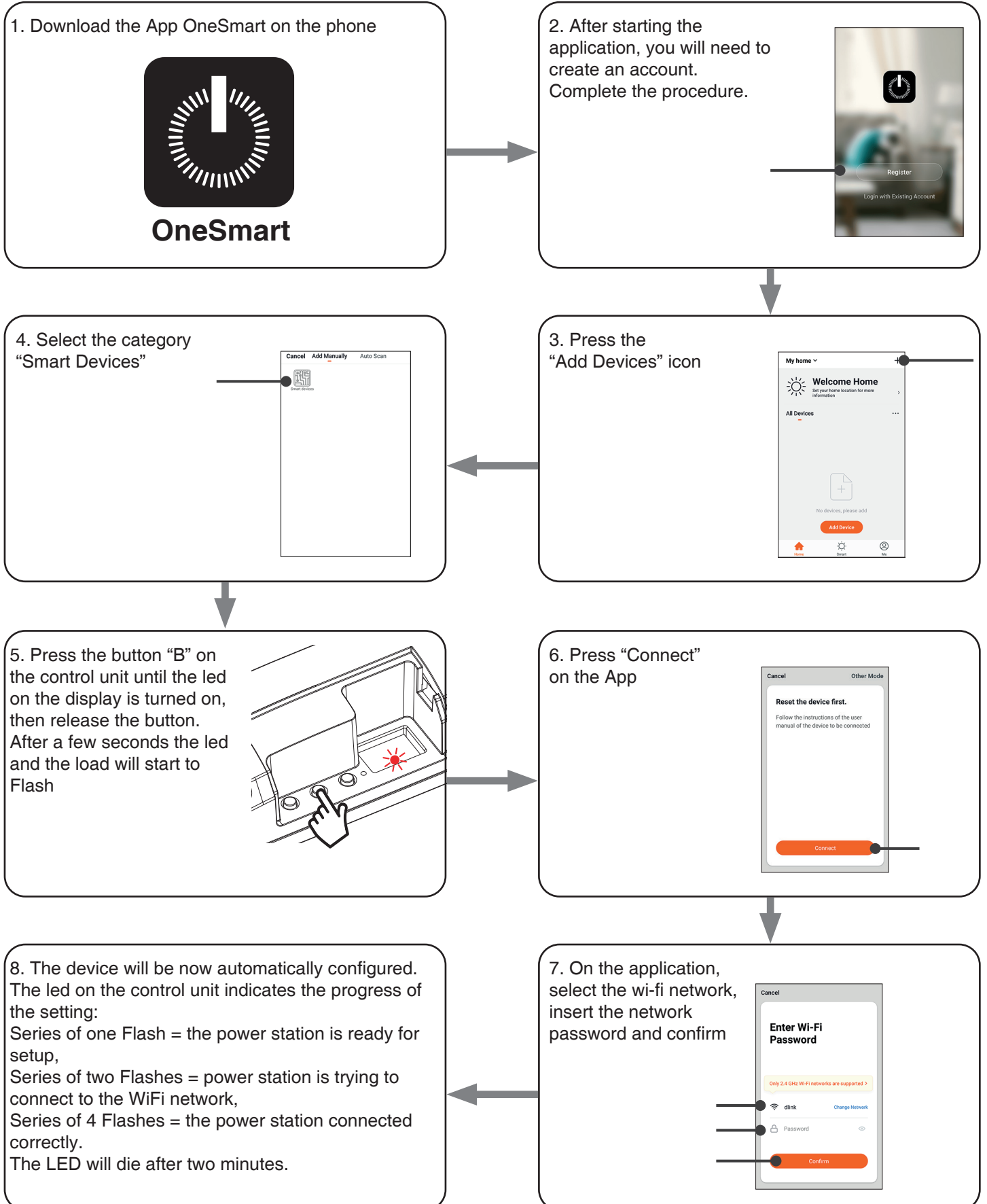

5.2 - USE OF THE APP ONE SMART

After all the control units have been set up, the installation can be managed by the application.

USE

The “Home” menu (1) shows all the associated devices.
To send a command to a device, select it.

Pressing “Smart” (2) allows you to add actions on your devices according to certain conditions and in certain time intervals, there are two types of actions:

- Automation (3): One or more actions happen if one or more conditions are satisfied
- Tap-to-Run (Scenario) (4): performs one or more actions by pressing an app button

EXAMPLES OF SCENARIOS (TAP-TO-RUN):

- Total off (switch off all the lights in the house)
- Scenario Soft (Dimming the desired lights at low intensity level)

EXAMPLES OF AUTOMATIONS:

- Hourly and weekly programmms
- Turn on the lights at the sunshine, turn off the lights at the sunrise.

Pressing “Me” (5) for entering to home and account settings.

From this menu, you can add members to the home for sharing device management or creating new houses.

PROCEDURE PFOR ADDING NEW USERS/MEMBERS.

1- From the “ME” menu (5), select “Home Management” (7) and then go to the house configurations and find “Add Member”

2- Insert the “OneSmart” account you want to add (email or mobile phone number of the new member), the new member will receive a notification of the invitation.

WARNING:

- The new user must have already downloaded the “OneSmart” application and created an account.
- Both the ‘administrator’ and the ‘new user’ must have set the same ‘region’ (Country).
- (Go to “Account (2)-Account and Security-Region” to view and change the set country).

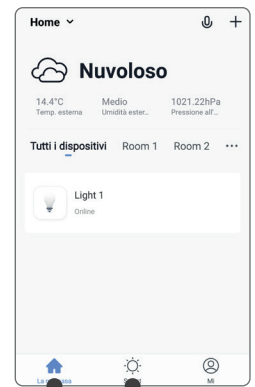

Home (1) Smart (2)

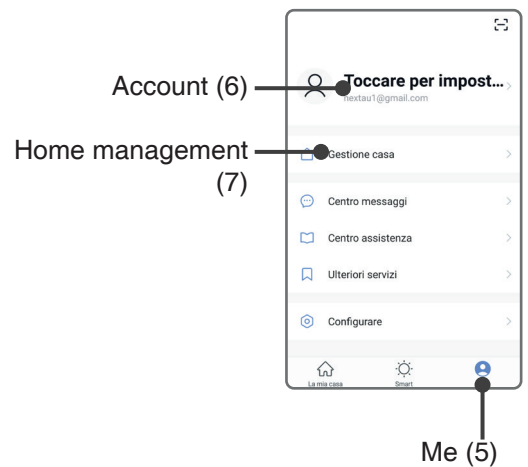
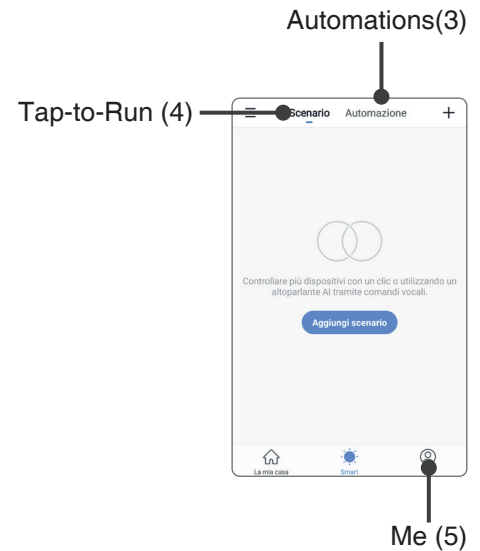

6 - CONTROL BY VOICE COMMANDS

You can use this procedure to associate a “OneSmart” account with a Google or Alexa account to enable the voice commands.

6.1 - CONNECTION TO “GOOGLE HOME”

PROCEDURE

WARNING: before proceeding with this procedure, you must have set up the “OneSmart” account, see paragraph 6.

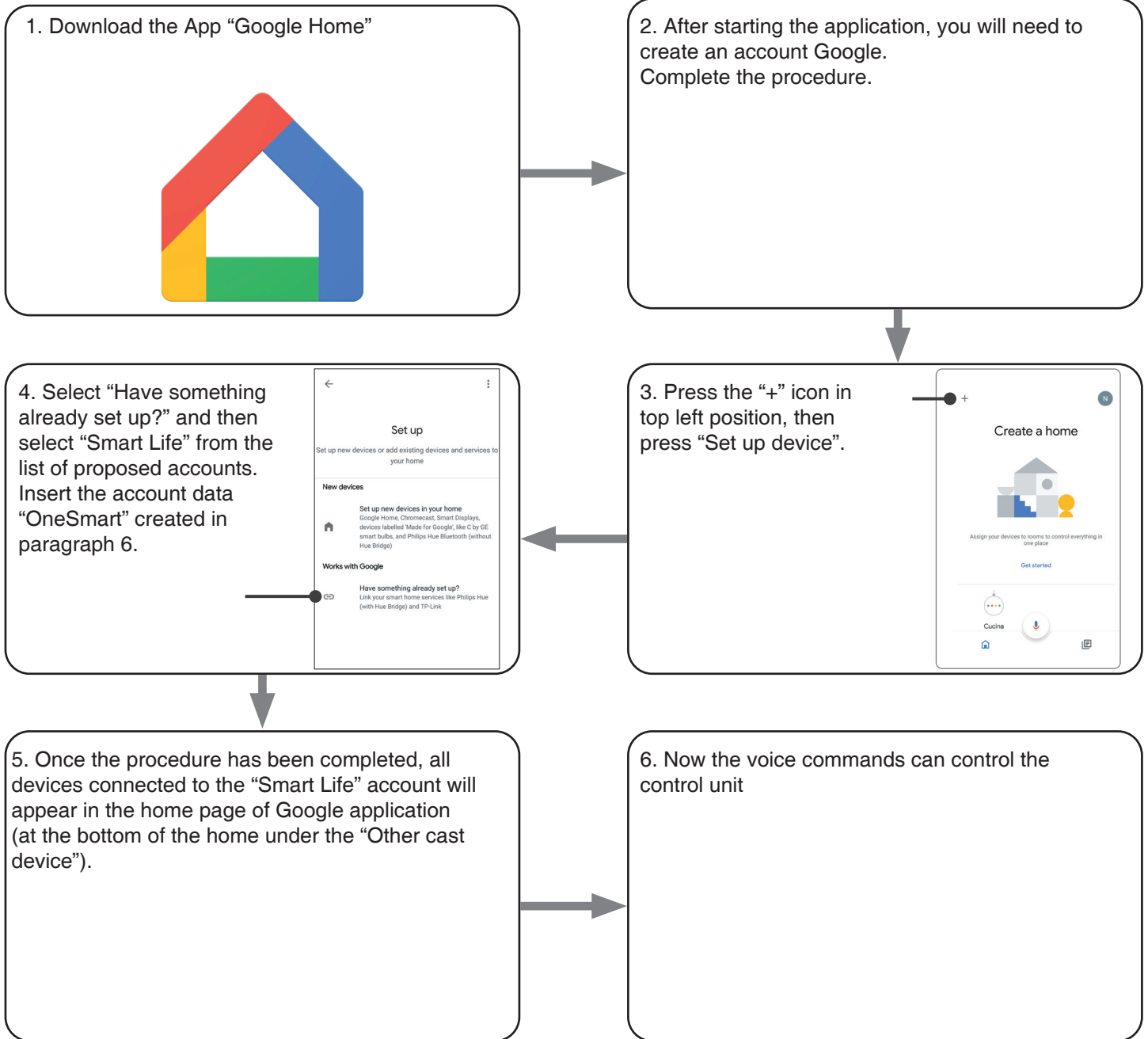

NOTES:

If you add other devices to your OneSmart application, they will automatically be added to the Google Home page. To use them with voice control, you need to add them to a room in the Google Home application, see step 6 of the procedure.

If devices are not added automatically, disconnect and reconnect your account from step 3 of this procedure from Google Home.

USE OF “GOOGLE HOME”

SENDING VOICE COMMANDS

Using your Android mobile phone (or tablet), voice commands can already be sent via the native assistant. By using an Apple device, you can use the microphone within the Google Home application. If you want to add a voice recognition device such as “Google Home Mini” or “Google Home”, follow the procedures to match it to the house you created and then they will be associated with the lights.

VOICE COMMAND LIST

Here below there are some examples of dedicated voice commands for lights:

DIMMER / RGB(W) / CCT TUNABLE WHITE

OK Google, Turn on / Turn Off *name of the device* or *name of the room*
OK Google, Turn on / Turn Off the lights
OK Google, set the light to 50%
OK Google, reduce the light
OK Google, turn off all the lights

RGB(W)

OK Google, transforms the light *light name* or *room name* green.
OK Google, set the *light name* or *room name* red

CCT TUNABLE WHITE

OK Google, Hot White
OK Google, Cold White
OK Google, Ancient White
OK Google, Smoke White
OK Google, Phantom White

USE OF ROUTINES

The Nexta control unit is compatible with Google routine.

The Google Home application allows you to create some vocal commands to be associated with one action or sequence of actions.

This allows you to create scenarios, but also allows you to customize the command to get a certain action.

EXAMPLES OF SCENARIOS

OK Google, Dark! Turn off all the lights
OK Google, Movie! Turn off some lights and soft dimming of other lights

EXAMPLES OF CUSTOMIZED COMMANDS

OK Google, Dark! Turn off the light
(corresponds to the native “Turn off *light name*” command)

6.2 - CONNECTION TO “AMAZON ALEXA”

PROCEDURE

WARNING: before proceeding with this procedure, you must have set up the “OneSmart” account, see paragraph 6.

1. Download the App “Amazon Alexa”



2. After starting the application, you will need to create an account Amazon.
Complete the procedure.

3. From the application home page press “menu” (1) then “Skill and games” (2). Press on the “Magnifying glass” at the top right and then search for “Smart Life” (3). Follow the procedure to enable use of the “OneSmart” account created using paragraph 6

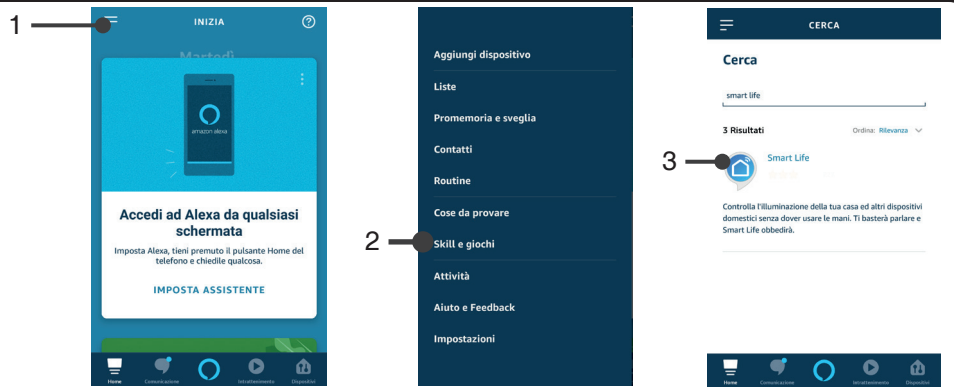

4. Complete the procedure by entering the “OneSmart” account data created in paragraph 6. You can then start searching for devices by pressing the “Discover devices” button (4). If you want, complete the setting-up procedure by inserting the device into a room.



5. Now the voice commands can control the control unit

USE OF “AMAZON ALEXA”

SENDING VOICE COMMANDS

Using your Android mobile phone (or tablet), voice commands can already be sent via the Amazon Alexa application.

Using an Apple device, you can use the microphone inside the Amazon Alexa application.

If you want to add a voice-control device like “Echo Dot” or “Echo Plus”, follow the procedures to match it to the house you created, and then they will be associated with the lights.

EVOICE COMMAND LIST

Here below there are some examples of dedicated voice commands for lights:

DIMMER / RGB(W) / CCT TUNABLE WHITE

Alexa, Turn on / Turn Off *name of the device* or *name of the room*

Alexa, Turn on / Turn Off the lights

Alexa, set the light to 50%

Alexa, reduce the light

Alexa, turn off all the lights

RGB(W)

Alexa, transforms the light *light name* or *room name* green.

Alexa, set the *light name* or *room name* red

7 - ADVANCED PROGRAMS

7.1 - FUNCTION CUSTOMIZATION OF THE “WIRELESS BUS” GENERIC TRANSMITTER BUTTONS

The following procedure allows you to set a custom function to the “wireless bus” family transmitter button.

GENERIC RADIOTRANSMITTERS (WIRELESS BUS), CODES:
HB80-6G, MCU-TX4, TOUCH-1G, TOUCH-2G, TOUCH-4G, TOUCH-LOCK4, TOUCH-TX2, ROUND-1G

PROCEDURE

STEP 1

Short presses on the “SET” key let you scroll through the menu until “P1” programming appears on the display.

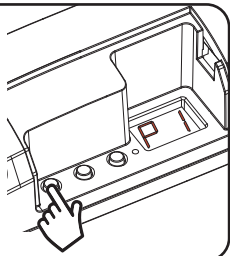

STEP 2

A prolonged press on the “SET” key (approx. 3 seconds) takes you into programming.

The LED on the receiver comes on

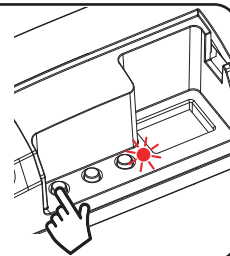

STEP 3

Short presses on key “B” let you choose the function you want to programme shown on the displays.

DISPLAY	FUNCTION
1	Function of pre-assigned key
2	On/Off
3	On
4	Off
5	Dimmer Up
6	Dimmer Down
7	Short press: On/Off - Prolonged press: Dimmer Up/Down
8	Short press: On - Prolonged press: Dimmer Up
9	Short press: Off - Prolonged press: Dimmer Down
0	Not used

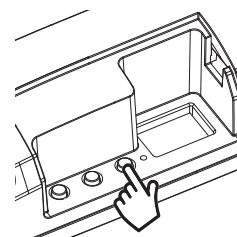

STEP 4

Give a long press on key “B” (approx. 3 seconds). The LED on the display comes on

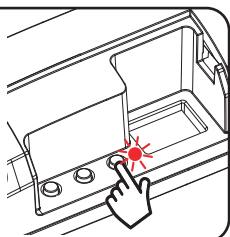

STEP 5

Make a transmission with the transmitter to be saved (see transmitter manual, the paragraph entitled “transmitter programming”).

The LED on the receiver flashes 3 times to signal that it has been received.

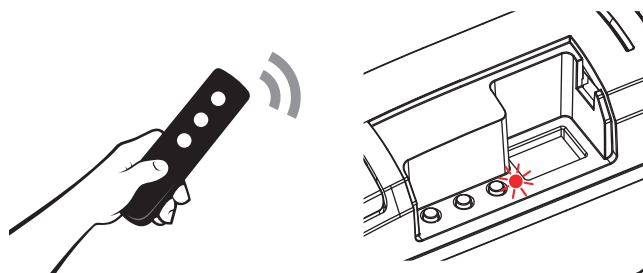

STEP 6

Give a short pressure on key “b”. The LED on the display turns off.

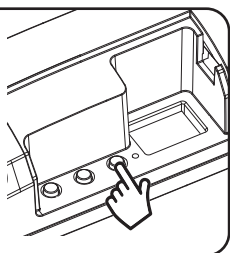

STEP 7

If you want to save other transmitters, go back to point 3 of this procedure. If you want to go back to the menu displaying the different types of programming, give a prolonged press to the “SET” key (approx. 3 seconds).

7.2 - "SAVE" FUNCTION (BRIGHTNESS LEVEL AT SWITCH-ON)

Default: all the loads come on at maximum brightness

With this procedure you can set the intensity value at which the loads come on.

PROCEDURE

STEP 1

Short presses on the "SET" key let you scroll through the menu until "P3" programming appears on the display.

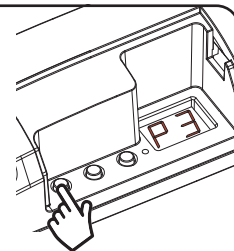

ACTION: Short press of button "SET" **DISPLAY:** "P3"

STEP 2

A prolonged press on the "SET" key (approx. 3 seconds) takes you into programming.

The LED on the receiver lights up

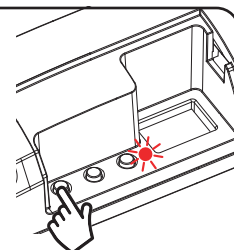

ACTION: Long press of button "SET" **DISPLAY:** "A_"

STEP 3

Make short presses on key "B" to choose the setting you want to set based on table alongside.

DISPLAY	FUNCTION
1	"SAVE" function on. The load will switch on at the last brightness value set before it was switched off
2	Switch-on of load at maximum intensity with white light

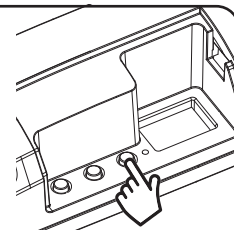

ACTION:
Short press of button "B"

STEP 4

To confirm give a prolonged press on the "SET" key (approx. 3 seconds). The control unit goes back to the main menu.

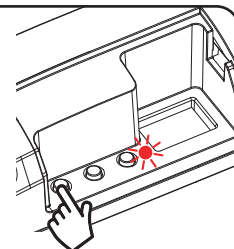

ACTION: Long press of button "SET" **DISPLAY:** Main menu

7.3 - FADE SETTING: GRADUAL SWITCH-ON

Default: switch-on in approx. 0.5

This procedure means you can set the duration of the switch-on time.

PROCEDURE

STEP 1

Short presses on the "SET" key let you scroll through the menu until "P4" programming appears on the display.

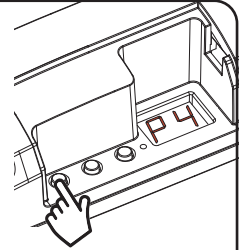

ACTION: Short press of button "SET" **DISPLAY:** "P4"

STEP 2

A prolonged press on the "SET" key (approx. 3 seconds) takes you into programming.

The LED on the receiver lights up

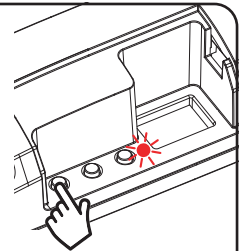

ACTION: Long press of button "SET" **DISPLAY:** "1"

STEP 3

Make short presses on key "B" to choose the setting you want to set based on table alongside.

DISPLAY	FADE ON
1	immediate ON
2	ON ~ 0,5s
3	ON ~ 2s
4	ON ~ 4s
5	ON ~ 10s

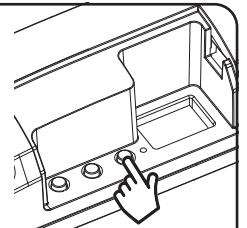

ACTION:
Short press of button "B"

STEP 4

To confirm give a prolonged press on the "SET" key (approx. 3 seconds). The control unit goes back to the main menu.

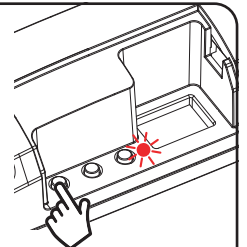

ACTION: Long press of button "SET" **DISPLAY:** Main menu

7.4 - FADE SETTING: GRADUAL SWITCH-OFF

Default: switch-off in approx. 0.5

This procedure means you can set the duration of the switch-on time.

PROCEDURE

STEP 1

Short presses on the "SET" key let you scroll through the menu until "P5" programming appears on the display.

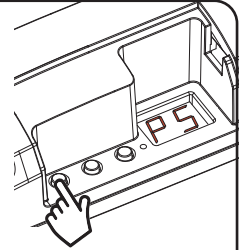

ACTION: Short press of button "SET" **DISPLAY:** "P5"

STEP 2

A prolonged press on the "SET" key (approx. 3 seconds) takes you into programming.

The LED on the receiver lights up

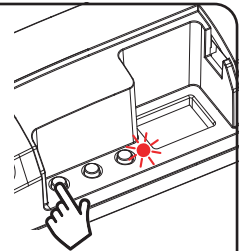

ACTION: Long press of button "SET" **DISPLAY:** "1"

STEP 3

Make short presses on key "B" to choose the setting you want to set based on table alongside.

DISPLAY	FADE OFF
1	immediate OFF
2	OFF ~ 0,5s
3	OFF ~ 2s
4	OFF ~ 4s
5	OFF ~ 10s

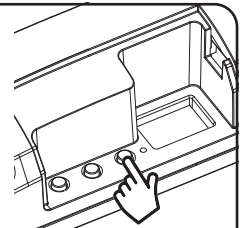

ACTION:
Short press of button "B"

STEP 4

To confirm give a prolonged press on the "SET" key (approx. 3 seconds). The control unit goes back to the main menu.

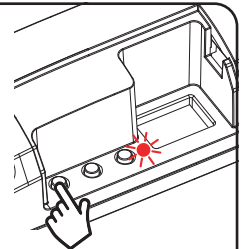

ACTION: Long press of button "SET" **DISPLAY:** Main menu

7.5 - SELECTION OF MINIMUM INTENSITY VALUE

Default: No minimum value

This procedure lets you select the minimum intensity value that can be set during normal operation.

PROCEDURE

STEP 1

Short presses on the "SET" key let you scroll through the menu until "P6" programming appears on the display.

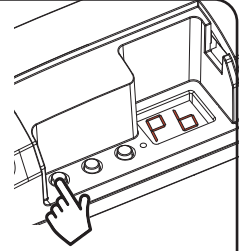

ACTION: Short press of button "SET" **DISPLAY:** "P6"

STEP 2

A prolonged press on the "SET" key (approx. 3 seconds) takes you into programming.

The LED on the receiver lights up

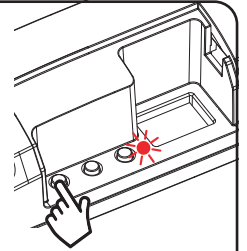

ACTION: Long press of button "SET" **DISPLAY:** "1"

STEP 3

Make short presses on key "B" to choose the setting you want to set based on table alongside.

DISPLAY	SELECTION OF MINIMUM INTENSITY VALUE
1	Default
2	Value Displayed: set the desired minimum intensity value

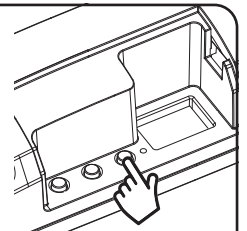

ACTION:
Short press of button "B"

STEP 4

To confirm give a prolonged press on the "SET" key (approx. 3 seconds). The control unit goes back to the main menu.

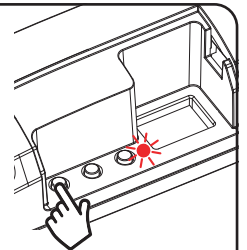

ACTION: Long press of button "SET" **DISPLAY:** Main menu

7.6 - LOAD STATE WHEN THE CONTROL UNIT IS SWITCHED ON

Default: No minimum value

This procedure lets you select the minimum intensity value that can be set during normal operation.

PROCEDURE

STEP 1

Short presses on the "SET" key let you scroll through the menu until "P8" programming appears on the display.

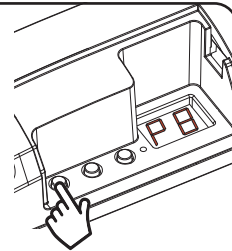

ACTION: Short press of button "SET" **DISPLAY:** "P8"

STEP 2

A prolonged press on the "SET" key (approx. 3 seconds) takes you into programming.

The LED on the receiver lights up

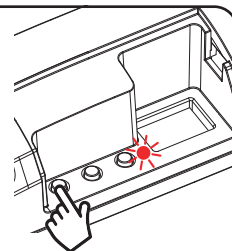

ACTION: Long press of button "SET" **DISPLAY:** "1"

STEP 3

Make short presses on key "B" to choose the setting you want to set based on table alongside.

DISPLAY	MINIMUM BRIGHTNESS THAT CAN BE SET
1	Default
2	Value Displayed: set the desired intensity value

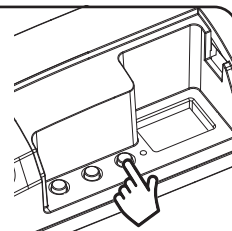

ACTION:
Short press of button "B"

STEP 4

To confirm give a prolonged press on the "SET" key (approx. 3 seconds). The control unit goes back to the main menu.

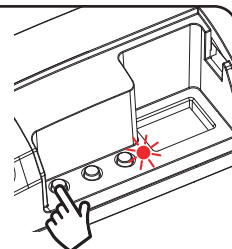

ACTION: Long press of button "SET" **DISPLAY:** Main menu

77 - "TIMED ON
Default: No timing

This process is used to set the time for which the Leds stays on before an automatic switch off.

PROCEDURE

STEP 1

Short presses on the "SET" key let you scroll through the menu until "P3" programming appears on the display.

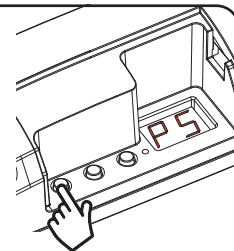

ACTION: Short press of button "SET" **DISPLAY:** "P3"

STEP 2

A prolonged press on the "SET" key (approx. 3 seconds) takes you into programming.

The LED on the receiver lights up

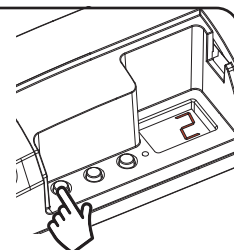

ACTION: Long press of button "SET" **DISPLAY:** "1_"

STEP 3

Make short presses on key "B" to choose the setting you want to set based on table alongside.

DISPLAY	TIMED ON
1	No Timing
2	1 minute
3	5 minutes
4	15 minutes
5	40 minutes
6	1 hour
7	2 hours
8	3 hours
9	8 hours

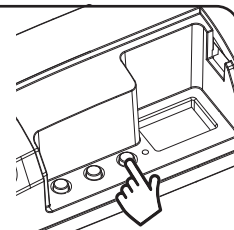

ACTION:
Short press of button "B"

STEP 4

To confirm give a prolonged press on the "SET" key (approx. 3 seconds). The control unit goes back to the main menu.

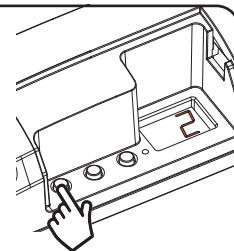

ACTION: Long press of button "SET" **DISPLAY:** Main menu

7.8 - CONTROL UNIT RESET

This procedure let you take the control unit back to factory settings.

PROCEDURE

STEP 1

Short presses on the "SET" key let you scroll through the menu until "FS" programming appears on the display.

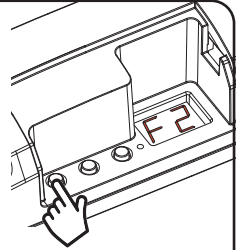

ACTION: Short press of button "SET" **DISPLAY:** "FS"

STEP 2

A prolonged press on the "SET" key (approx. 3 seconds) takes you into programming.
The LED on the receiver lights up

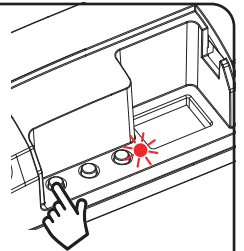

ACTION: Long press of button "SET" **DISPLAY:** "F_"

STEP 3

Make short presses on key "B" to choose the setting show on display

DISPLAY	FUNCTION
F1	reset factory parameters, but no deletion of already programmed transmitters
F2	full reset of factory parameters, even stored transmitters will be deleted

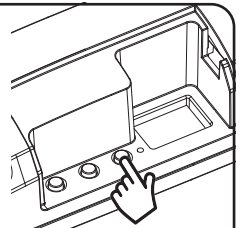

ACTION:
Short press of button "B"

STEP 4

To confirm, give a prolonged press on the "SET" key (approx. 3 seconds).
The LED Flashes

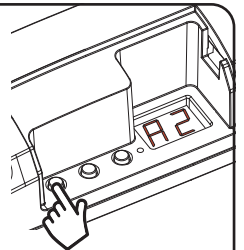

ACTION: Long press of button "SET" **DISPLAY:** Main menu



V2.0



LEF LIGHTING S.R.L.

Via Rodolfo Morandi 9/11

50019 Sesto Fiorentino

Tel. 055.4217727

Firenze - ITALY

www.leflighting.it