

PLANO-ONE

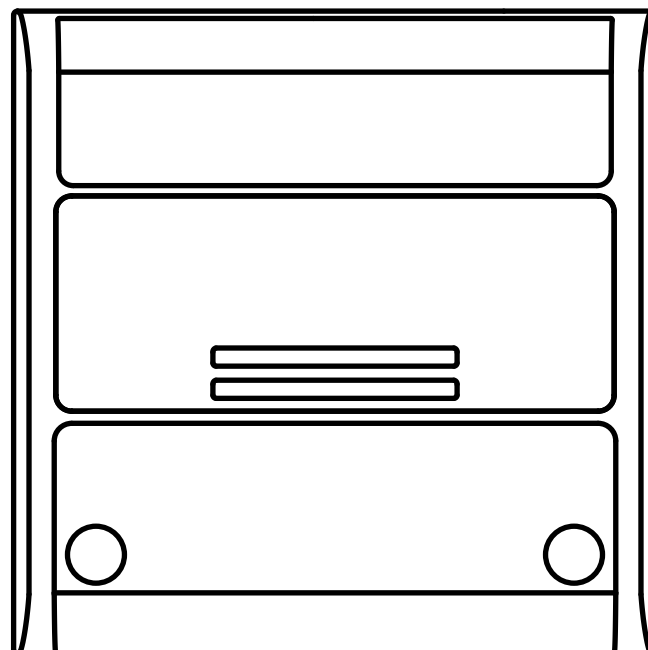

**Universal control unit for constant voltage LEDs 12-24Vdc, selectable software for LED type 1. Single color dimmer, 2. RGB, 3 RGBW, 4. CCT tunable white.
Power supply 12-24Vdc, Max 5A /output (max 10A total).
Integrated 433.92 MHz radio receiver.
WiFi connection for OneSmart App.**

INDEX

1 - PRODUCT FEATURES	
1.1 - TECHNICAL DATA	page 3
2 - CONNECTION DIAGRAMS	
2.1 - SINGLE-COLOR LED CONNECTION DIAGRAM	page 5
2.2 - CCT - TUNABLE WHITE LED CONNECTION DIAGRAM	page 6
2.3 - RGB - RGBW LED CONNECTION DIAGRAM	page 7
3 - LED TYPE SETTING	
3.1 - TYPES OF SELECTABLE LEDs	page 8
3.2 - PROCEDURE FOR LED TYPE SETTING	page 9
4 - USE OF THE CONTROL UNIT	
4.1 - TYPICAL INSTALLATION	page 10
4.2 - USE VIA WIRE	page 11
4.3 - USE VIA RADIO	page 11
4.4 - USE WITH SMARTPHONE APPLICATION	page 11
4.5 - USE WITH VOICE CONTROL	page 11
5 - CONTROL BY RADIOTRANSMITTERS	
5.1 - RADIOTRANSMITTER SETTING	page 12
5.2 - DELETION OF RADIOTRANSMITTERS	page 13
6 - CONTROL WITH APP ONE SMART	
6.1 - APP ONE SMART CONNECTION	page 14
6.2 - USE OF THE APP ONE SMART	page 15
7 - CONTROL BY VOICE COMMANDS	
7.1 - CONNECTION TO THE APP "GOOGLE HOME"	page 16
7.2 - CONNECTION TO THE APP "AMAZON ALEXA"	page 18
8 - ADVANCED PROGRAMS	
8.1 - BUTTON FUNCTION OF THE "WIRELESS BUS" RADIOTRANSMITTER TYPE	page 19
8.2 - LOAD STATE WHEN THE CONTROL UNIT IS SWITCHED ON	page 22
8.3 - TIMED ON SETTING	page 23
8.4 - FACTORY SETTINGS, RESET CONTROL UNIT	page 24
9 - FURTHER DETAILS	
9.1 - LOAD MEMORY SETTING	page 25

1 - PRODUCT FEATURES

1.1 TECHNICAL DATA

	Single color Dimmer (see section 2.1)	CCT Tunable white (see section 2.2)	RGB or RGBW (see section 2.3)
Power supply (Input)		12 - 24 Vdc	
LED type (Output)	Constant tension single color LED	Constant tension CCT LED	Constant tension RGB or RGBW LED
Max power load (Output)		5A per output, max 10 A total (4 outputs)	
N° of programmable transmitters		30	
RF receiver frequency		433.920MHz	
WiFi frequency		2.4GHz	
Protection rating		IP20	
Working temperature		-20° +55°	
Box dimensions		80 X 80 h16 mm	

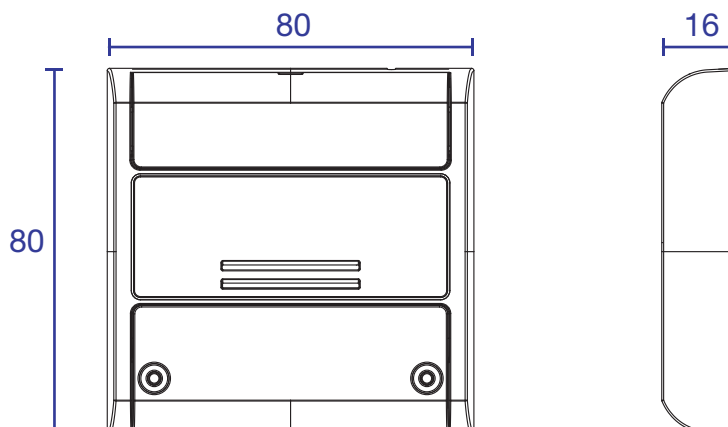
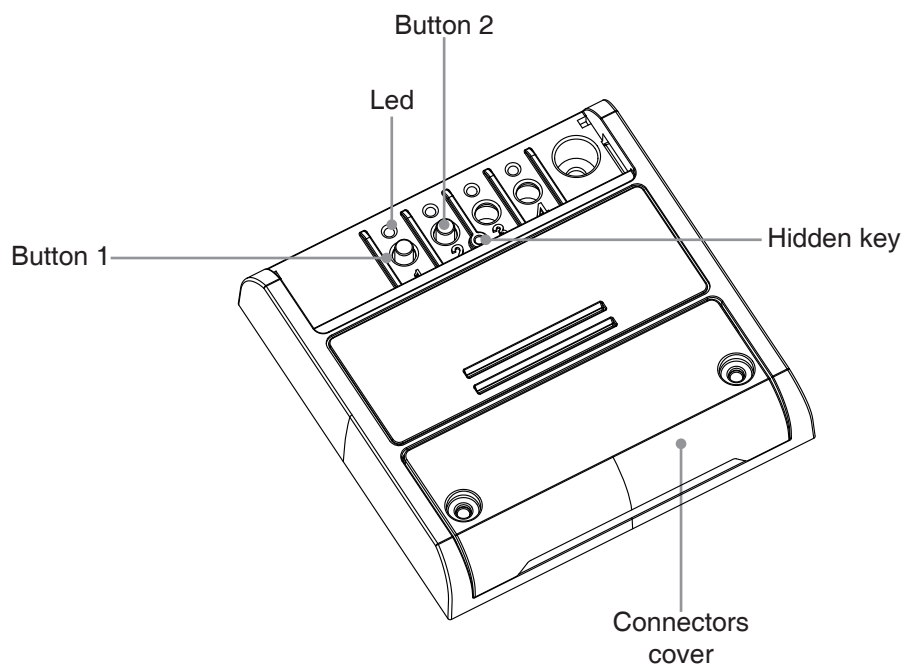

2 - CONNECTION DIAGRAMS

The control unit Plano-One can control 4 different types of LED: Single-color, RGB, RGBW, CCT Tunable white LEDs. By default, operation is set for a single-color LED. If a different strip type is used, follow the paragraph 3 procedure

RECOMMENDATIONS

- Installation must be carried out only by professional technicians in accordance with the applicable electrical and safety regulations.
- All connections shall be operated without electrical voltage.
- Use proper cables.
- Don't cut the antenna
- Provide in the power line twith an appropriate disconnection device
- Dispose of waste materials in full compliance with local law.
- Do not exceed the specified load limits and use correctly protected power supplies.

2.1 SINGLE-COLOR CONNECTION DIAGRAM

With the default settings, the control unit is set to control a single-color LED.

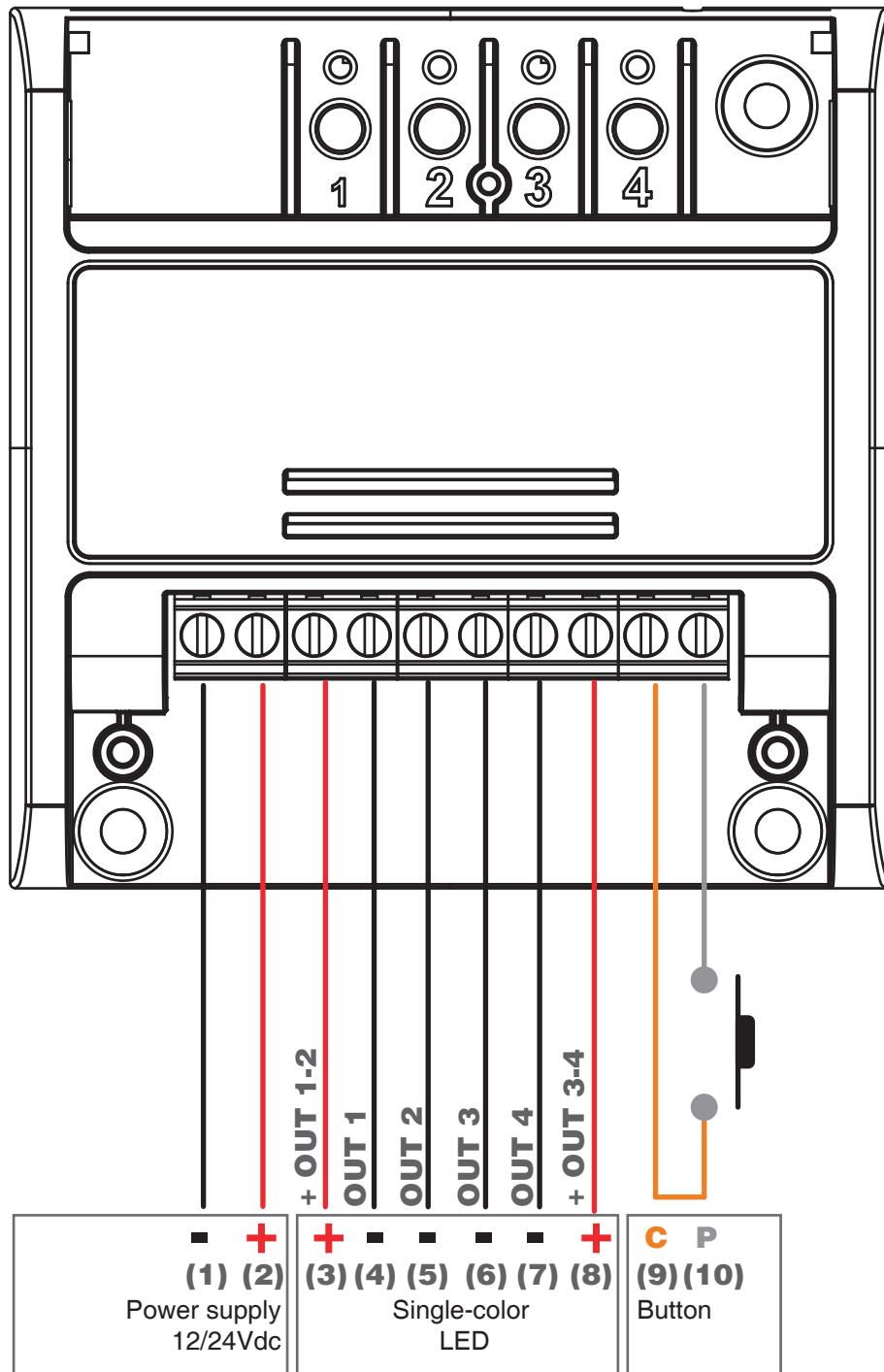

WARNING:

- Connect up to 5A per output and max total 10A
- The outputs are synchronized

USE VIA WIRE

SHORT PRESS:

LONG PRESS WITH LOAD ON:

LONG PRESS WITH LOAD OFF:

On-Off

Dimmer down - Dimmer up

Dimmer up

2.2 CCT TUNABLE WHITE LED CONNECTION DIAGRAM

With the default settings, the control unit is set to control a single-color led.
 Change the setting to “Tunable White Mode 1” or “Tunable White Mode 2” using the paragraph 3 procedure.

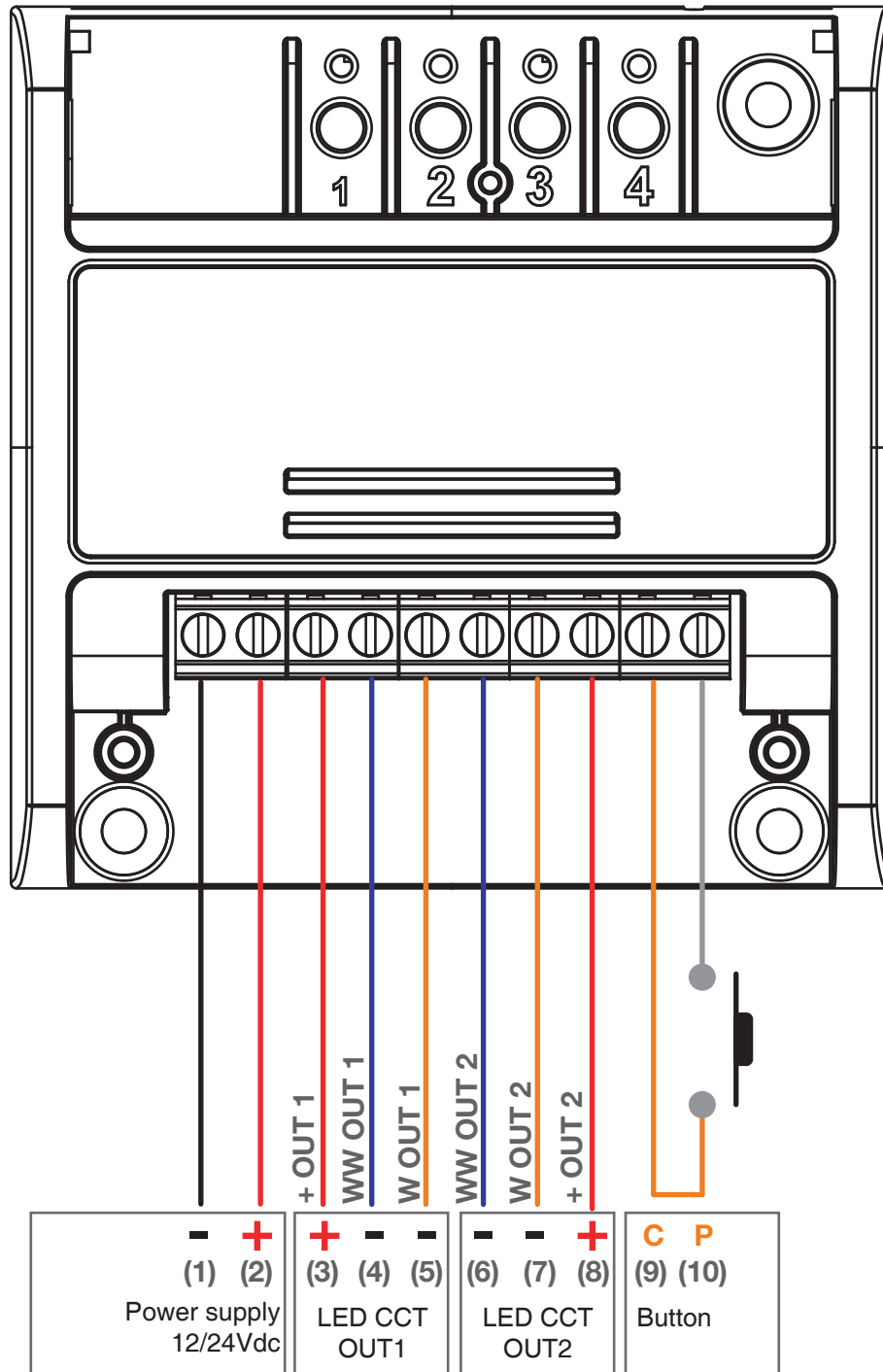

WARNING:

- Connect up to 5A per output and max total 10A
- The outputs are synchronized

USE VIA WIRE

SHORT PRESS:

LONG PRESS WITH LOAD ON:

LONG PRESS WITH LOAD OFF:

On-Off

Dimmer down - Dimmer up

Light temperature change (6 temperature levels)

2.3 RGB OR RGBW CONNECTION DIAGRAM

With the default settings, the control unit is set to control a single-color led.
 Change the setting to “RGB”, “RGBW Mode 1” or “RGBW Mode 2” using the paragraph 3 procedure.

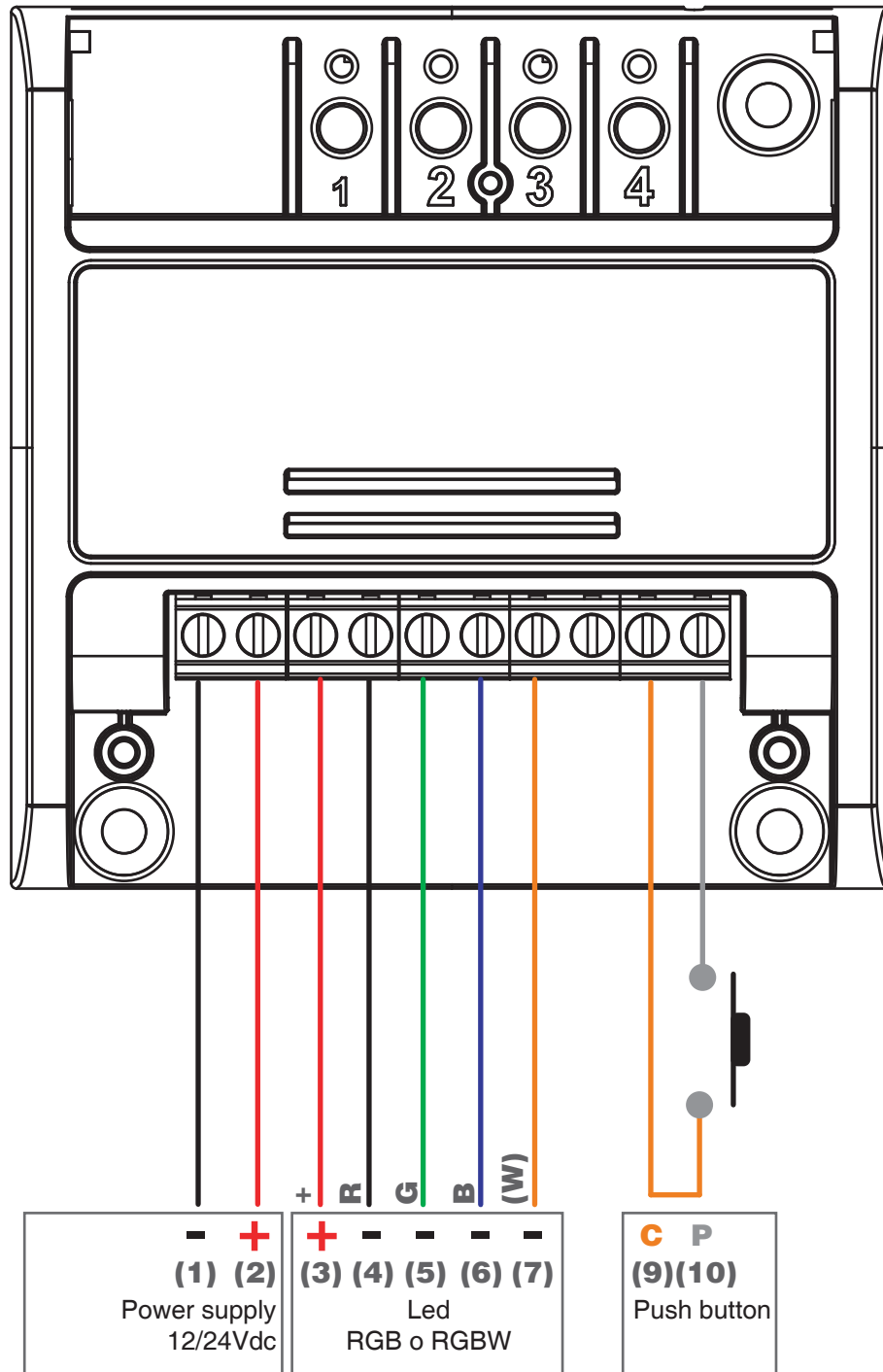

WARNING:

- Connect up to 5A per output and max total 10A

USE VIA WIRE

SHORT PRESS:

LONG PRESS WITH LOAD ON:

LONG PRESS WITH LOAD OFF:

On-Off

Dimmer down - Dimmer up

Color chage (red, yellow, green, light blue, blue, violet, white)

3 - LOAD TYPE SETTING

Default: Single-color LED.

This procedure allows you to change the type of the connected LED.

WARNING:

The procedure of connection with the OneSmart APP (see paragraph 6) must be repeated each time the load type is changed.

3.1 SELECTABLE LED TYPES

1. SINGLE-COLOR LIGHT

- The control unit is set for managing 4 single-color lights in synchronized working way.

2. CCT LIGHT - MODE 1

- The control unit is set for managing 2 CCT lights in synchronized working way.

The white light will be managed in the following way:

COLD LIGHT	INTERMEDIATE VALUE	NEUTRAL LIGHT	INTERMEDIATE VALUE	WARM LIGHT
Warm Led= 0% Cold Led= 100%	Warm Led= 25% Cold Led= 75%	Warm Led= 50% Cold Led= 50%	Warm Led= 75% Cold Led= 25%	Warm Led= 100% Cold Led= 0%

3. CCT LIGHT - MODE 2

- The control unit is set for managing 2 CCT lights in synchronized working way.

The white light will be managed in the following way:

COLD LIGHT	INTERMEDIATE VALUE	NEUTRAL LIGHT	INTERMEDIATE VALUE	WARM LIGHT
Warm Led= 0% Cold Led= 100%	Warm Led= 50% Cold Led= 100%	Warm Led= 100% Cold Led= 100%	Warm Led= 100% Cold Led= 50%	Warm Led= 100% Cold Led= 0%

4. RGB

- The control unit is set for managing 1 RGB light. The white light is obtained by the sum of the three outputs (R, G, B)

5. RGBW - MODE 1

- The control unit is set for managing 1 RGBW light. The white light is obtained by the 4th output (W)

6. RGBW - MODE 2

- The control unit is set for managing 1 RGBW light. The white light is obtained by the sum of the three outputs (R, G, B) and the 4th output (W)

ATTENTION: depending on the load type setting, a different sizing of the power supply unit may be required

3.2 - PROCEDURE FOR SETTING THE LED TYPE

PROCEDURE

STEP 1

Press and hold buttons 1 and 2 simultaneously (approximately 2 seconds) until the LED becomes green.

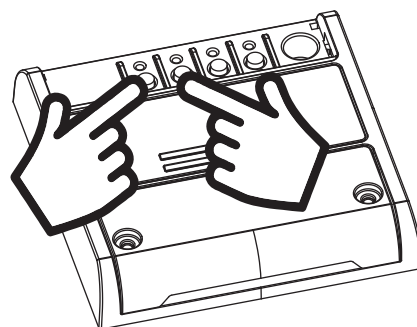

ACTION: Long press of buttons 1 and 2 **LED:** green

STEP 2

Make a short press of button 1 on the receiver and count the number of LED Flashes.

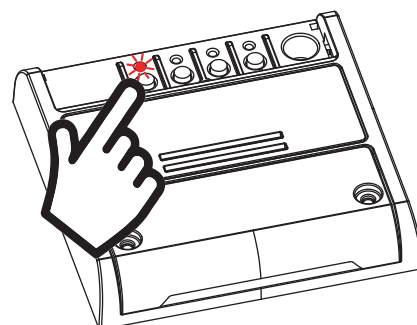

ACTION: Short press button 1
LED: Count the number of Flashes

NUMBER OF FLASHES	TYPE OF LED	DESCRIPTION
1	SINGLE-COLOR (See diagram paragraph 2.1)	4 Single-color lights with synchronized working way
2	CCT - MODE 1 (See diagram paragraph 2.2)	2 CCT lights with synchronized working way. Neutral White light = 50% Warm led + 50% Cold Led
3	CCT - MODE 2 (See diagram paragraph 2.2)	2 CCT lights with synchronized working way. Neutral White light = 100% Warm led + 100% Cold Led
4	RGB (See diagram paragraph 2.3)	1 RGB light. White light = R+G+B
5	RGBW - MODE 1 (See diagram paragraph 2.3)	1 RGBW light. White light = W
6	RGBW - MODE 2 (See diagram paragraph 2.3)	1 RGBW light. White light = R+G+B+W

STEP 3

Press the button P1 during the during the Flash that corresponds to the function desired to end the count.

(e.g. for choosing RGB mode push the button immediately after the fourth Flash)

The yellow LED on the board blinks a number of times corresponding to the set function

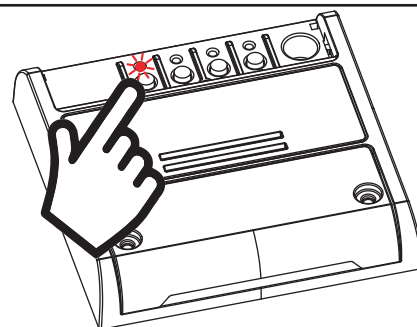

ACTION: Short press button 1 **LED:** yellow blinking

WARNING: if no setting is confirmed during step 3, the control unit maintains the load type previously set.

4 - USE OF THE CONTROL UNIT

4.1 TYPICAL INSTALLATION

The system can be controlled by a wired push button, radio commands, smartphone App OneSmart or voice commands. The installation can operate with only radio controls or application only. Instead, to use voice commands, at least the App configuration must be completed.

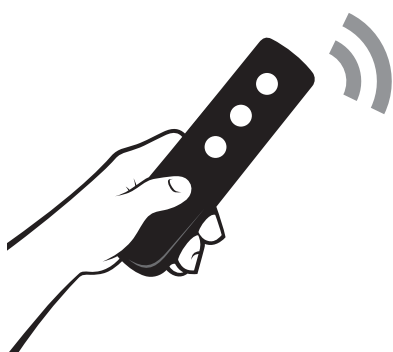

RADIOTRANSMITTER CONFIGURATION

See paragraph 5

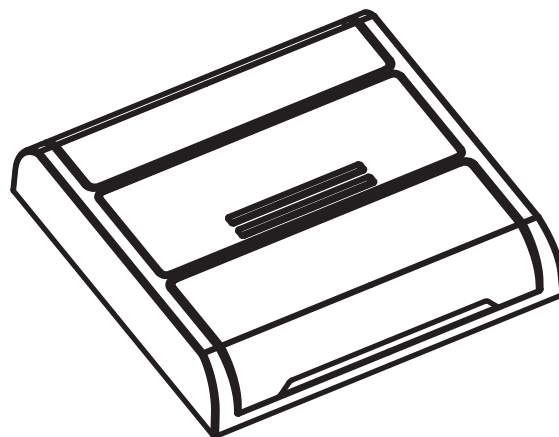

NEXTA CONTROL UNIT

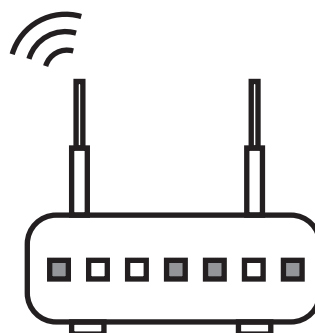

ROUTER WITH INTERNET
CONNECTION



APP CONTROL CONFIGURATION

See paragraph 6



VOICE CONTROL CONFIGURATION

See paragraph 7

4.2 USE VIA WIRE

Depending on the light type you set, the button will have several functions. See paragraph 2 for details.

4.3 USE VIA RADIO

To control the loads via radio you must have compatible transmitters and therefore must carry out the association procedure, see paragraph 5.

4.4 USE VIA SMARTPHONE APP ONESMART

The configuration procedures described in paragraph 6 above must be followed to control the lights by smartphone App.

4.5 USE WITH VOICE CONTROL

The configuration procedures described in paragraph 7 above must be followed to control the lights by voice commands.

5 - MANAGEMENT WITH REMOTE CONTROL

This procedure lets you programme/delete compatible multifunctional or generic (Wireless bus) transmitters

Multifunctional transmitters, codes:

HB70-SLCT, HB70-SPCT,
HB80-1C, HB80-1DIM, HB80-2L, HB80-30D, HB80-30RGBW, HB80-4C, HB80-4DIM, HB80-4L,
HB90-6LT,
ROUND-1SP,
SENSA-M, SENSA-P, SENSA-R35M, SENSA-R35P, SENSA-R35T, SENSA-T,
TOUCH-1, TOUCH-1CCT, TOUCH-1DIM, TOUCH-1SP, TOUCH-1L, TOUCH-1RGBW, TOUCH-3C, TOUCH-4DIM, TOUCH-CFU

With multifunctional transmitters the transmitter control modes depend on the model used.

Refer to the transmitter manual, to the paragraph entitled “commands sent by the transmitter”, bearing in mind that:

single-color mode= dimmer

tunable white mode= CCT

rgb / rgbw mode= RGB/W

Generic (wireless bus) transmitters, codes:

HB80-6G, MCU-TX4, TOUCH-1G, TOUCH-2G, TOUCH-4G, TOUCH-LOCK4, TOUCH-TX2, ROUND-1G

With generic transmitters, the function of the button is:

SHORT PRESS: On/Off

LONG PRESS, LIGHT ON: dimmer Up/Down

LONG PRESS, LIGHT OFF:

single-color mode= dimmer Up

CCT-tunable white mode= change light temperature (cold/warm)

rgb / rgbw mode= change color

The functions of the generic transmitters can be customized using the procedure in paragraph 8.1.

5.1 - RADIO PROGRAMMING

This procedure lets you programme compatible multifunctional or generic transmitters.

STEP 1

Press the button 1.
The led turns on red.

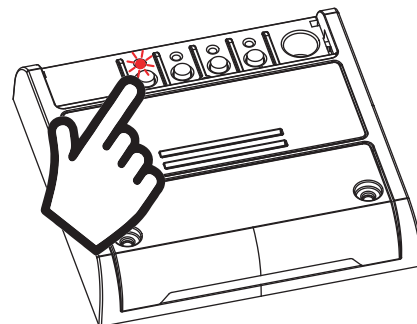

ACTION: Short press of button 1 **LED:** Turns on red

STEP 2

Within 60 seconds make a transmission with the transmitter to be saved.
See transmitter manual, the paragraph entitled “transmitter programming” for specify information.
The led makes 3 Flashes and turns off.

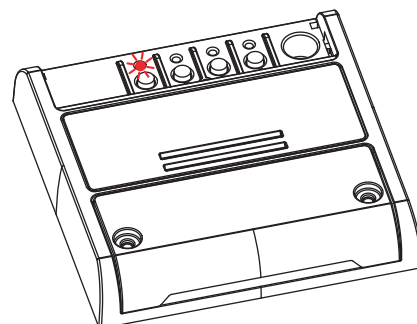
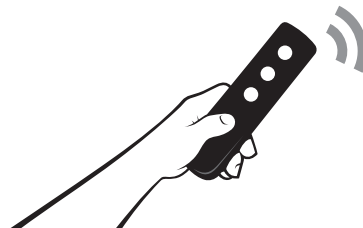

ACTION: Make a transmission with the transmitter **LED:** Flashes 3 times

5.2 - DELETION OF REMOTE CONTROL

These procedures let you delete from the memory transmitters that have already been programmed.

STEP 1

Hold the receiver button 1 down (about 5 seconds.) until the LED begins to Flash.

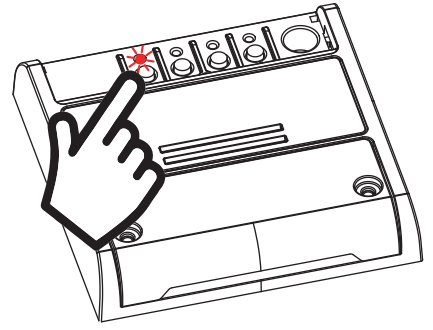

ACTION: Hold tbutton 1 down **LED:** Flashes red

**DELETION OF SINGLE
TRANSMITTER**

**DELETION OF ALL
TRANSMITTER SAVED**

STEP 2a

Within 10 seconds make a transmission with the transmitter that you want to delete.
The LED flashes quickly and turns off.

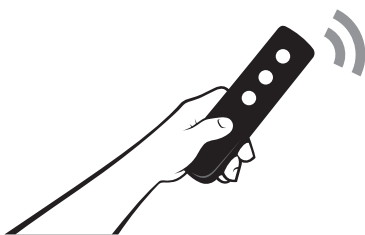
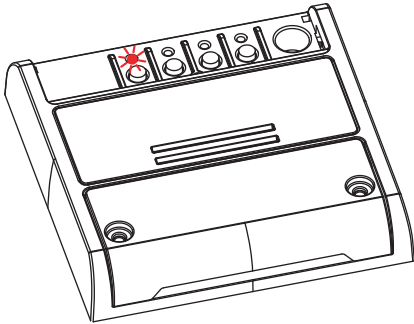

ACTION: Make a transmission with the transmitter
LED: Flashing quickly and turns off

STEP 2B

Within 10 seconds press the button 1 on the receiver for a short time to confirm the deletion of all transmitters.
The LED starts flashing quickly and turns off.

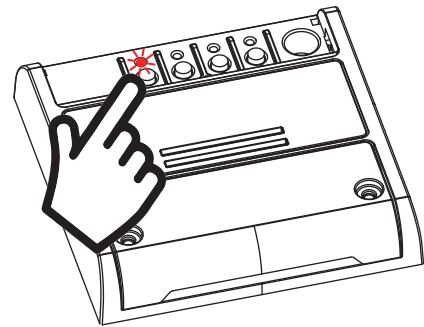

ACTION: Short press of button 1
LED: Flashing quickly and turns off

6 - CONTROL WITH APP ONE SMART

These procedures allow you to manage the light from your device (example: mobile phone) through the application and to control the system remotely.

6.1 - APP CONNECTION

This procedure connects the control unit Plano-One to the application. It shall be repeated for each control unit on the installation.

ATTENTION: an internet-based wi-fi network is required for te operation.

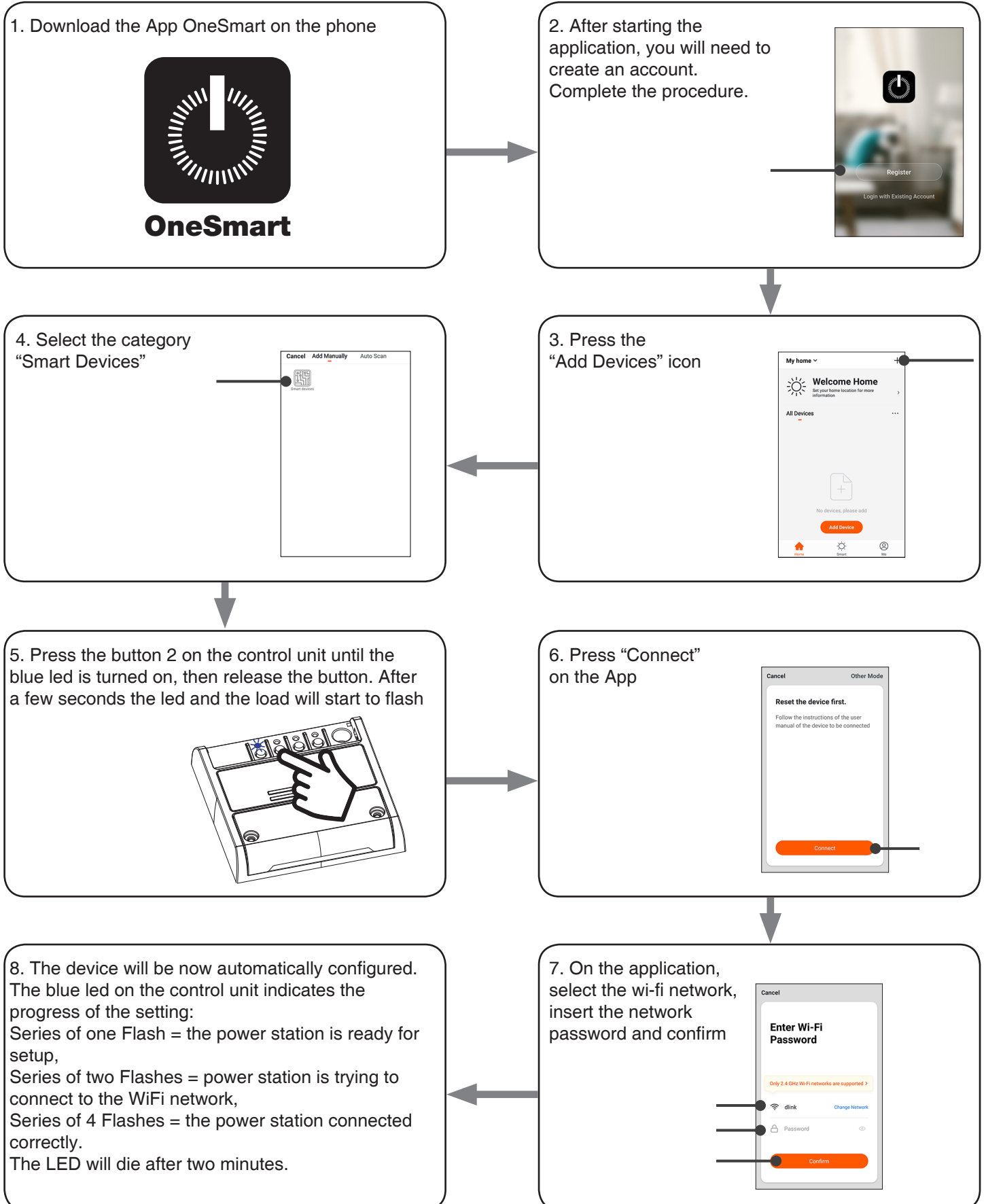

6.2 - USE OF THE APP ONE SMART

After all the control units have been set up, the installation can be managed by the application.

USE

The “Home” menu (1) shows all the associated devices.
To send a command to a device, select it.

Pressing “Smart” (2) allows you to add actions on your devices according to certain conditions and in certain time intervals, there are two types of actions:

- Automation (3): One or more actions happen if one or more conditions are satisfied
- Tap-to-Run (Scenario) (4): performs one or more actions by pressing an app button

EXAMPLES OF SCENARIOS (TAP-TO-RUN):

- Total off (switch off all the lights in the house)
- Scenario Soft (Dimming the desired lights at low intensity level)

EXAMPLES OF AUTOMATIONS:

- Hourly and weekly programmings
- Turn on the lights at the sunshine, turn off the lights at the sunrise.

Pressing “Me” (5) for entering to home and account settings.

From this menu, you can add members to the home for sharing device management or creating new houses.

PROCEDURE PFOR ADDING NEW USERS/MEMBERS.

1- From the “ME” menu (5), select “Home Management” (7) and then go to the house configurations and find “Add Member”

2- Insert the “OneSmart” account you want to add (email or mobile phone number of the new member), the new member will receive a notification of the invitation.

WARNING:

- The new user must have already downloaded the “OneSmart” application and created an account.
- Both the ‘administrator’ and the ‘new user’ must have set the same ‘region’ (Country).
- (Go to “Account (2)-Account and Security-Region” to view and change the set country).

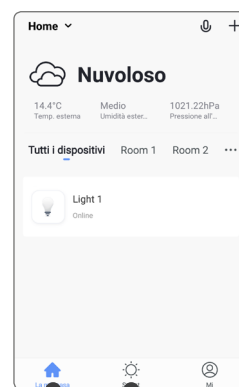

Home (1) Smart (2)

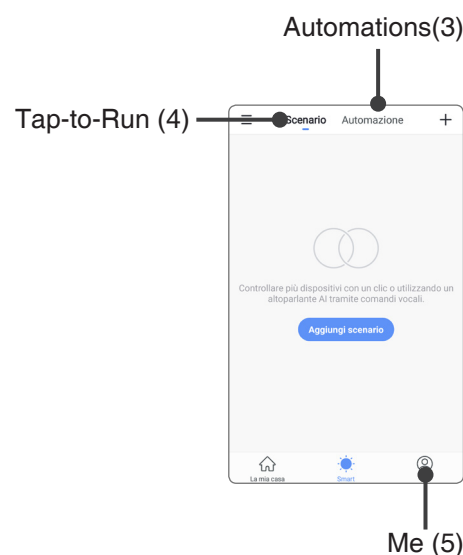

Tap-to-Run (4)

Me (5)

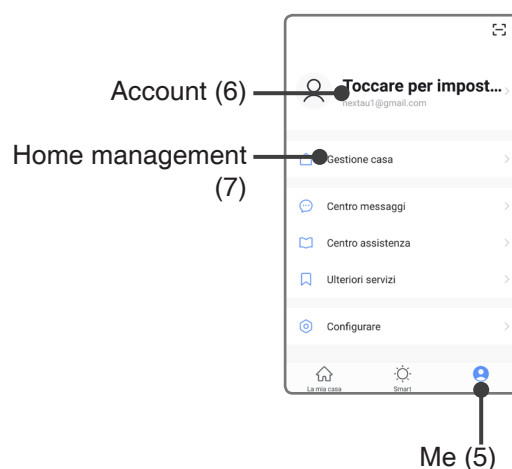

Account (6)

Home management (7)

Me (5)

7 - CONTROL BY VOICE COMMANDS

You can use this procedure to associate a “OneSmart” account with a Google or Alexa account to enable the voice commands.

7.1 - CONNECTION TO “GOOGLE HOME”

PROCEDURE

WARNING: before proceeding with this procedure, you must have set up the “OneSmart” account, see paragraph 6.

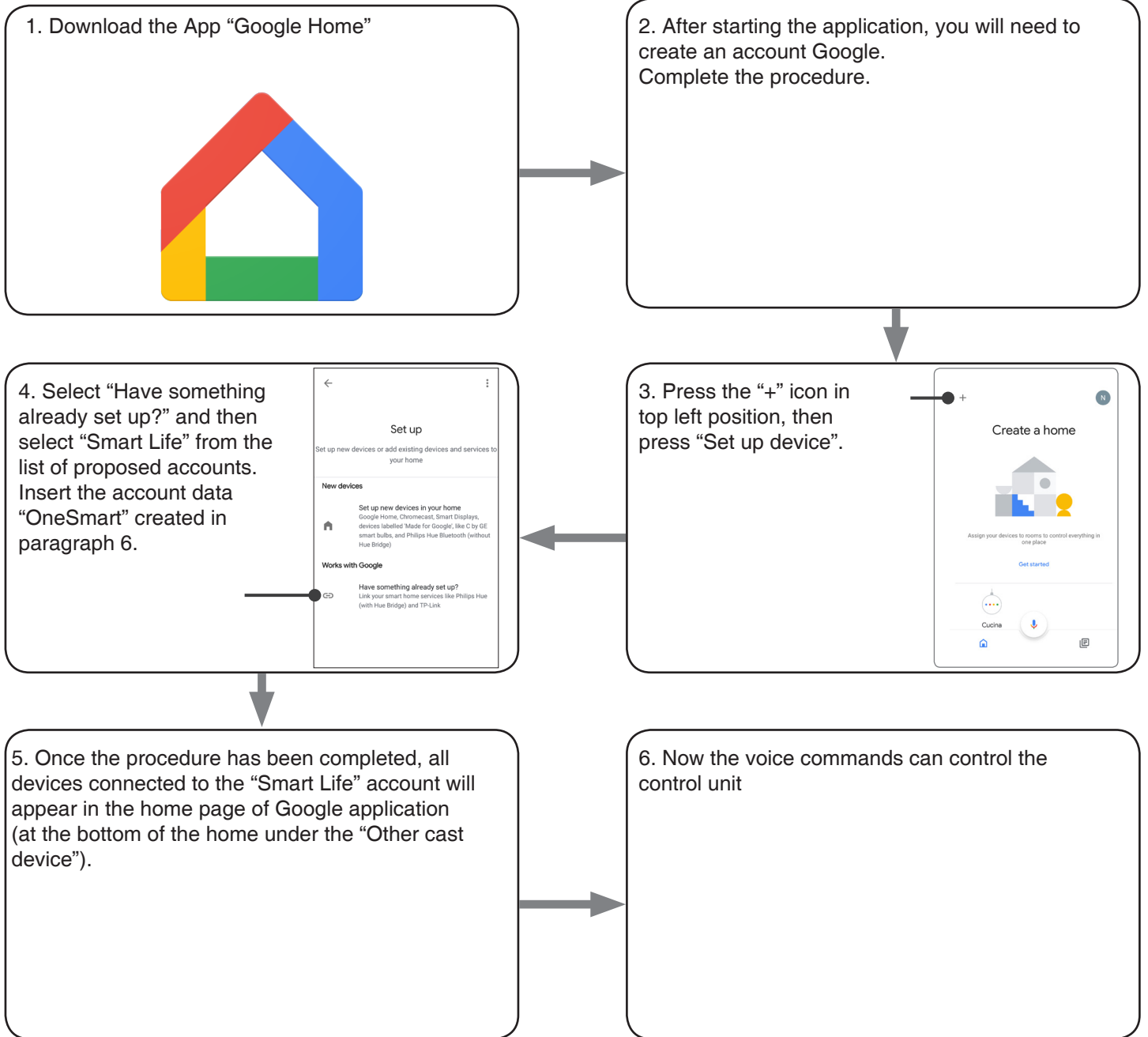

NOTES:

If you add other devices to your OneSmart application, they will automatically be added to the Google Home page. To use them with voice control, you need to add them to a room in the Google Home application, see step 6 of the procedure.

If devices are not added automatically, disconnect and reconnect your account from step 3 of this procedure from Google Home.

USE OF “GOOGLE HOME”

SENDING VOICE COMMANDS

Using your Android mobile phone (or tablet), voice commands can already be sent via the native assistant. By using an Apple device, you can use the microphone within the Google Home application. If you want to add a voice recognition device such as “Google Home Mini” or “Google Home”, follow the procedures to match it to the house you created and then they will be associated with the lights.

VOICE COMMAND LIST

Here below there are some examples of dedicated voice commands for lights:

DIMMER / RGB(W) / CCT TUNABLE WHITE

OK Google, Turn on / Turn Off *name of the device* or *name of the room*
OK Google, Turn on / Turn Off the lights
OK Google, set the light to 50%
OK Google, reduce the light
OK Google, turn off all the lights

RGB(W)

OK Google, transforms the light *light name* or *room name* green.
OK Google, set the *light name* or *room name* red

CCT TUNABLE WHITE

OK Google, Hot White
OK Google, Cold White
OK Google, Ancient White
OK Google, Smoke White
OK Google, Phantom White

USE OF ROUTINES

The Nexta control unit is compatible with Google routine.

The Google Home application allows you to create some vocal commands to be associated with one action or sequence of actions.

This allows you to create scenarios, but also allows you to customize the command to get a certain action.

EXAMPLES OF SCENARIOS

OK Google, Dark! Turn off all the lights
OK Google, Movie! Turn off some lights and soft dimming of other lights

EXAMPLES OF CUSTOMIZED COMMANDS

OK Google, Dark! Turn off the light
(corresponds to the native “Turn off *light name*” command)

7.2 - COONNECTION TO “AMAZON ALEXA”

PROCEDURE

WARNING: before proceeding with this procedure, you must have set up the “OneSmart” account, see paragraph 6.

1. Download the App “Amazon Alexa”



2. After starting the application, you will need to create an account Amazon.
Complete the procedure.

3. From the application home page press “menu” (1) then “Skill and games” (2). Press on the “Magnifying glass” at the top right and then search for “Smart Life” (3). Follow the procedure to enable use of the “OneSmart” account created using paragraph 6

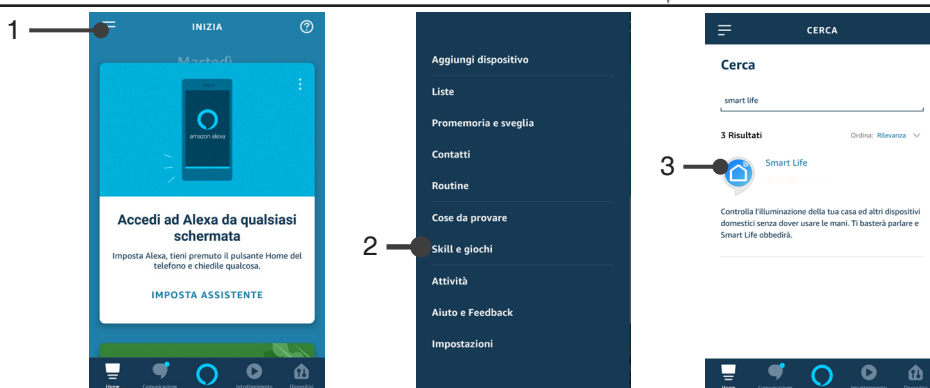

4. Complete the procedure by entering the “OneSmart” account data created in paragraph 6. You can then start searching for devices by pressing the “Discover devices” button (4). If you want, complete the setting-up procedure by inserting the device into a room.

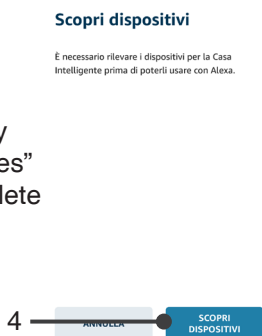

5. Now the voice commands can control the control unit

USE OF “AMAZON ALEXA”

SENDING VOICE COMMANDS

Using your Android mobile phone (or tablet), voice commands can already be sent via the Amazon Alexa application.

Using an Apple device, you can use the microphone inside the Amazon Alexa application.

If you want to add a voice-control device like “Echo Dot” or “Echo Plus”, follow the procedures to match it to the house you created, and then they will be associated with the lights.

EVOICE COMMAND LIST

Here below there are some examples of dedicated voice commands for lights:

DIMMER / RGB(W) / CCT TUNABLE WHITE

Alexa, Turn on / Turn Off *name of the device* or *name of the room*

Alexa, Turn on / Turn Off the lights

Alexa, set the light to 50%

Alexa, reduce the light

Alexa, turn off all the lights

RGB(W)

Alexa, transforms the light *light name* or *room name* green.

Alexa, set the *light name* or *room name* red

8 - ADVANCED PROGRAMS

8.1 FUNCTION CUSTOMIZATION OF THE “WIRELESS BUS” GENERIC TRANSMITTER BUTTONS

The following procedure allows you to set a custom function to the “wireless bus” family transmitter button.

GENERIC RADIOTRANSMITTERS (WIRELESS BUS), CODES:
HB80-6G, MCU-TX4, TOUCH-1G, TOUCH-2G, TOUCH-4G, TOUCH-LOCK4, TOUCH-TX2, ROUND-1G

Details on selectable functions.

Function 6 - Play/Stop Color Cycle

When the button is pressed, the load emits:

- a flash to signal the play cycle
- two flashes to signal stop cycle

Function 7 - Speed/Effect Change

- Each time the button is pressed with a short pressure, the load emits:
 - - a Flash to signal the cycle speed of 10 seconds
 - - two Flashes to signal 30 seconds cycle speed
 - - three Flashes to signal 90 seconds cycle speed
 - - four Flashes to signal the cycle speed of 4 minutes
 - - five Flashes to report cycle speed of 15 minutes
 - - six Flashes to signal the cycle speed of 1 hour

- Each time the button is pressed with a long pressure, the load is set to a different cycle:
 - color cycle displays all tones
 - color cycle with green and blue tones
 - color loop c with blue and purple tones
 - color cycle with blue, purple and pink tones
 - color cycle with red and orange tones
 - color cycle with orange and yellow tones

Function 8 - Memo

Each time the button is pressed, the load will Flash to indicate that the current state of the light is stored.

If the button is pressed from state “light off”, the storage is switched off and the light will be turned back on to the last set value, as it is by default.

See paragraph 9.1

PROCEDURE

STEP 1

Press the button 1.
The led turns on red.

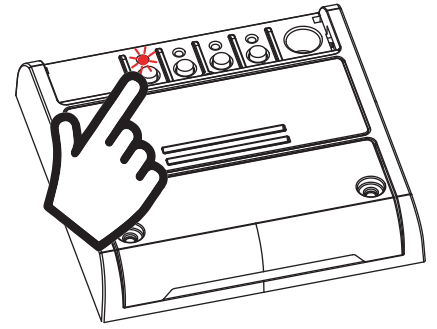

ACTION: Short press of button 1 **LED:** Turns on red

STEP 2

Press the button 2 on the receiver for a short time and count the number of Flashes emitted by the LED:

NUMBER OF FLASHES	FUNCTION
1	Off
2	On
3	Short press: On Long press: Dimmer Up
4	Short press: Off Long press: Dimmer Down
5	Short press: Color change or temperature change by step Long press: Gradual Color change or temperature change
6	Play/Stop color cycle
7	Short press: Speed change Long press: Color cycle change
8	Memo

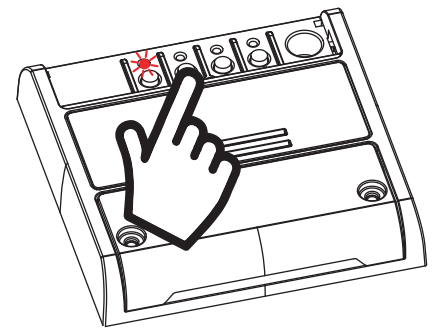

ACTION:
Short press of button 2
LED:
Count the number of Flashes

STEP 3

Press the button for a short time during the Flash that corresponds to the function desired to end the count.
The led stop Flashes

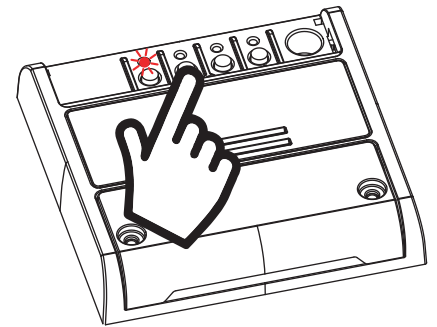

ACTION: Short pressure of button 2 during the Flash **LED:** Stop Flashes

STEP 4

Make a transmission with the transmitter to be saved (see transmitter manual, paragraph entitled "transmitter programming").
The LED on the receiver Flashes 3.times and turns off.

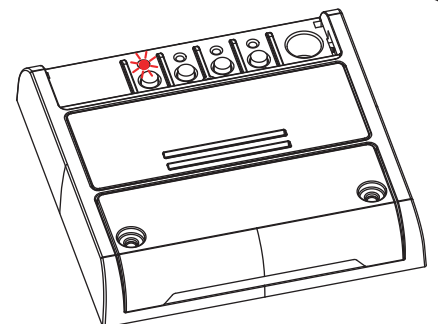
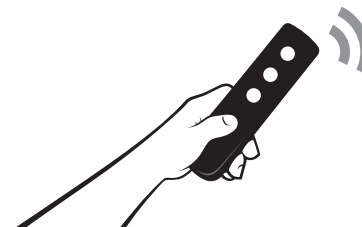

ACTION: Make a transmission with the transmitter **LED:** Flashes 3 times

8.2 - LOAD STATE WHEN THE CONTROL UNIT IS SWITCHED ON

Default: Last value before the black out

This process is used to set the state of Leds when the control unit is switched on (for example when the power supply is provided by a general switch or timer).

PROCEDURE:

STEP 1

set the light on the desired state.

The state as well as re-call a color or intensity level can also be a color cycle.

NOTE: light state cannot be set as off.



STEP 2

With a paper clip make a long press of the "hidden" button.

The LED is cyclically yellow and green.

Release the key when the led is yellow.

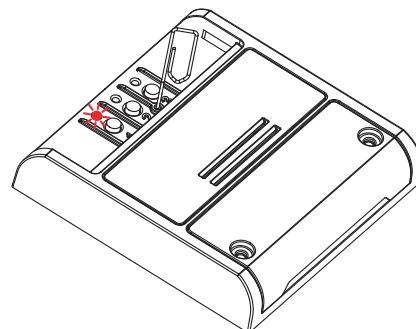

ACTION: Long press of the "hidden" button **LED:** Turns on green/yellow



STEP 3

Make a short press on button 2 of the receiver.

The led Flashes yellow.

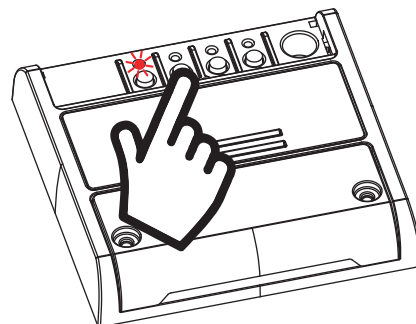

ACTION: Short press of button 2 **LED:** Flashes



STEP 4

Make a short press on button 2 of the receiver to confirm.

The led turns off.

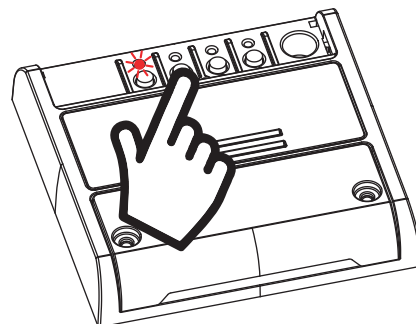

ACTION: Short press of button 2 **LED:** Turns off

* function deactivation

To set up the default value, set the light OFF at step 1 of the procedure

8.3 - SETTING THE TIMED ON

Default: 24 hours

This procedure is used to set the time for which the Leds stays on before an automatic switch off.

All commands reset the time count to zero, excluding the following commands that will immediately turn off the light: short press by wired push button, command OFF by radiotransmitter, comand by App or voice.

PROCEDURE

STEP 1

With a paper clip makes a long press of the "hidden" button.
The LED is cyclically yellow and green.
Release the key when the led is yellow.

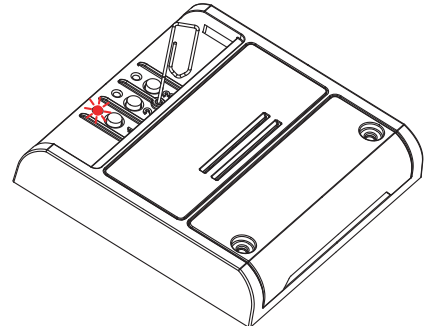

ACTION: Long press of the "hidden" button **LED:** Turns on green/yellow

STEP 2

Press the button 1 on the receiver for a short time and count the number of Flashes emitted by the LED:

FLASHES NUMBER	FUNCTION
1	No timed on
2	1 minute
3	5 minutes
4	15 minutes
5	30 minutes
6	1 hour
7	2 hours
8	3 hours
9	8 hours
10	12 hours
11	18 hours

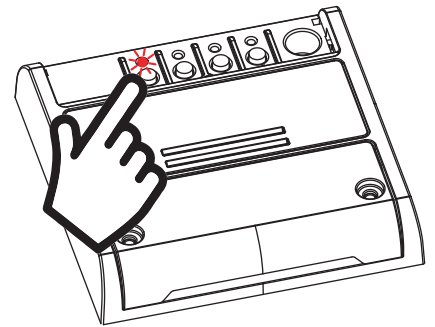

ACTION: Short press of button 1
LED: Count the number of Flashes

STEP 3

Press the button for a short time during the Flash that corresponds to the function desired to end the count.
The led turns off

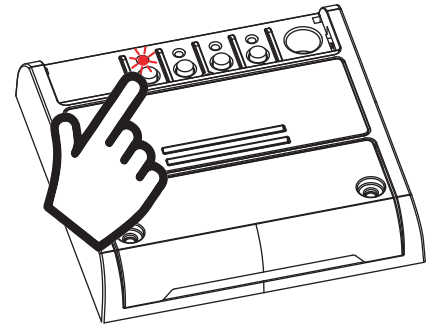

ACTION: Short press of button 1 during the Flashes **LED:** Turns off

8.4 - SETTING TYPE OF INPUTS VIA WIRE

Default: Button function

This procedure lets you choose the type of wired devices to command load (connected on terminals 9 and 10). The devices can be set as buttons or switches.

PROCEDURE

STEP 1

With a paper clip makes a long press of the “hidden” button.
The LED is cyclically yellow and green.
Release the key when the led is yellow.

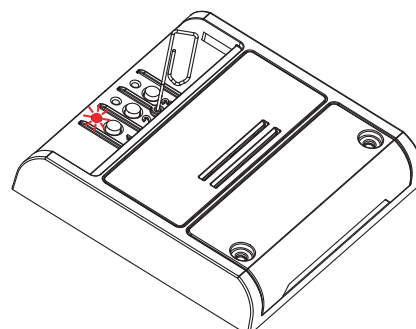

ACTION: Long press of hidden button **LED:** Turns on yellow/green

STEP 2

Press the button on the receiver for a short time and count the number of Flashes emitted by the LED:
3 Flashes = control with buttons
6 Flashes = control with switches

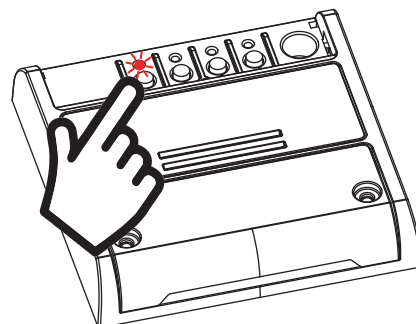

ACTION: Short press of button 2 **LED:** Flashes

STEP 3

To change the setting, repeat the procedure from point 1; the control unit will alternate between 3 and 6 Flashes

8.4 - RESET OF THE CONTROL UNIT

This procedure let you take the control unit back to factory settings.

ATTENTION: the only parameter that will not be removed will be the association with the ONESMART application (see paragraph 6). To edit or delete also this parameter, reed the procedure.

PROCEDURE

STEP 1

Hold the receiver button 1 down (about 5 seconds.) until the LED begins to Flash.

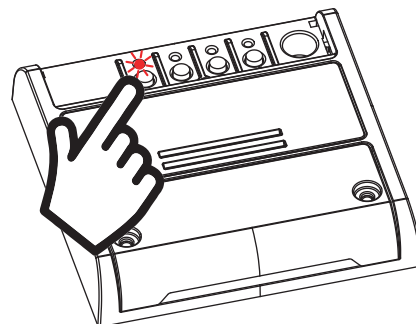

ACTION: Long press of button 1 **LED:** Flashes red



STEP 2

Within 10 seconds, make a short press of "hidden" button.
The LED 1 Flashes quickly and turns off.

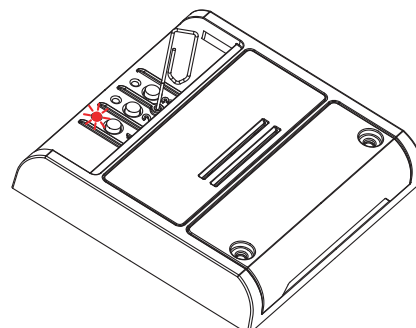

ACTION: Make a short press of hidden button **LED:** the led Flash quicly and turns off



MN0PLN-ONEENV1.0



LEF LIGHTING S.R.L.

Via Rodolfo Morandi 9/11

50019 Sesto Fiorentino

Tel. 055.4217727

Firenze - ITALY

www.lefgroup.com